

Discrete Controller Design for A Hybrid Three Tank System

Cyril Joseph[#], V. I. George[#], P. R. Venkateswaran^{*}

[#] *Instrumentation and Control, Manipal University, MIT, Manipal, 576104, India*
E-mail: cyril.cholenkery@gmail.com, vig_rect@yahoo.com

^{*} *Welding Research Institute, BHEL, Thiruchirappalli, 620014, India*
E-mail: prv_i@yahoo.com

Abstract— Systems in which the dynamical behaviour evolves based on the interaction between the continuous dynamics and the discrete dynamics, present in the system, are called hybrid systems. Traditionally such systems were analysed either as purely continuous or purely discrete systems. The interactions between discrete and continuous systems in today's technological problems have become so important that hybrid modelling of such systems is called for. In this paper a discrete controller is designed for such a hybrid system. Hybrid modelling technique is used to model the hybrid three tank systems. The hybrid model is simulated in SIMULINK and STATEFLOW is used to design the discrete controller.

Keywords— Hybrid systems, discrete controller, hybrid modelling, three tank system.

I. INTRODUCTION

Hybrid systems are dynamical systems that involve the interactions of different types of dynamics. In this paper hybrid dynamics that arise out of interactions of continuous state dynamics and discrete state dynamics are considered. Hybrid systems involve both types of dynamics: discrete jumps and continuous flows. The analysis and design of hybrid systems is in general more difficult than that of purely discrete or purely continuous systems, due to the affect of discrete dynamics with the continuous evolution and vice versa [1].

Hybrid dynamics provide a convenient framework for modeling systems in a wide range of engineering applications. E.g. in mechanical systems: continuous motion may be interrupted by collisions. In electrical circuits: continuous phenomena such as the charging of capacitors, etc. are interrupted by switches opening and closing, or diodes going on or off. In embedded computation systems a digital computer interacts with a mostly analogue environment. In chemical process control the continuous evolution of chemical reactions is controlled by valves and pumps. In all these systems it is convenient to model the discrete components as introducing instantaneous changes in the continuous components.

In the last two decades a lot of research has been carried out in the field of modeling, system identification, controller design and observer design for hybrid systems. Many design tools for modeling of different classes of hybrid systems

have been developed [2]. In this paper a chemical process control system is considered as the hybrid system. Three tank system is a well-known benchmark system used for testing of controller algorithms, fault detection, modeling etc. Three tank system is modeled as a hybrid system and a controller is designed for the same. A hybrid systems approach is implemented to model and design the controller for the system.

II. THREE TANK SYSTEM

Three-tank system can be used as a benchmark system for system modeling, system identification, control, fault detection and diagnosis, as well as for fault-tolerant control. The system exhibits typical characteristics of a constrained hybrid system and has been proven useful to serve as a test environment for algorithms concerning state estimation, parameter identification, and control of hybrid systems. Here two configurations of the system are considered for the controller design[3]. The three tank system is shown in Fig.1.

A. System description

The system consists of three cylindrical tanks, T1, T2 and T3. T1 and T2 is filled with liquid by two identical, independent pumps. The pumps deliver the liquid flows Q_1 and Q_2 and they can be continuously manipulated from a flow of 0 to a maximum flow Q_{max} . The tanks are interconnected to each other through pipes. The flow through these pipes can be interrupted with binary switching

valves V_{13} , V_{23} that can assume either the completely open or the completely closed position. The liquid levels h_1 , h_2 , h_3 , in each tank can be measured with level sensors. The nominal outflow from the system is located at the middle tank (T3), i.e. V_{L3} . The outflows Q_{L1} and Q_{L2} through valves V_{L1} and V_{L2} are zero in nominal behavior and are used to model failures of the system. The system represents a chemical processing unit, with the outflow Q_{N3} as the product.

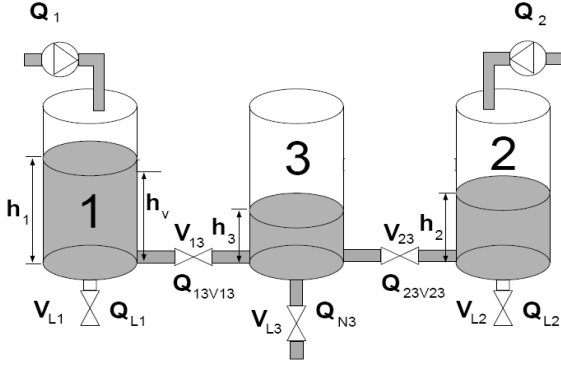

Fig. 1. Three tank system

B. Hybrid modelling of three tank system

The three tank system is modelled using the mixed logical dynamical modelling framework. In this framework the continuous dynamics and the discrete dynamics are modelled separately. From the conservation of mass in the tanks we obtain the following differential equations.

$$\begin{aligned} \dot{h}_1 &= \frac{1}{A}(Q_1 - Q_{13V13} - Q_{L1}) \\ \dot{h}_2 &= \frac{1}{A}(Q_2 - Q_{23V23} - Q_{L2}) \\ \dot{h}_3 &= \frac{1}{A}(Q_{13V13} + Q_{23V23} - Q_{N3}) \end{aligned} \quad (1)$$

Q is the flow from the valve. A is the cross-sectional area of each tank.

Table. 1. Variables of the three tank system

Symbol	Meaning
h_i	Water level in tank i ($i = 1, 2, 3$)
Q_i	Inflow through pump i ($i = 1, 2$)
Q_{ijVh}	Flow between tank i and tank j through valve V_h
Q_{Li}	Outflow due to leak in tank i ($i = 1, 2$)
Q_{N3}	Outflow from tank 3
V_h	Status of valve h ($0 = \text{closed}$, $1 = \text{open}$)

Assuming that the flow obeys the Torricelli's law, the flow through a lower valve V_{i3} is given by:

$$Q_{i3V_{i3}} = V_{i3} \frac{S_{i3}}{A} \text{sign}(h_i - h_3) \sqrt{2g(h_i - h_3)} \quad (i = 1, 2) \quad (2)$$

The flow through the valves V_{L1} , V_{L2} and V_{N3} are given in similar way:

$$\begin{aligned} Q_{L1} &= V_{L1} \frac{S_{L1}}{A} \sqrt{2gh_1} \\ Q_{L2} &= V_{L2} \frac{S_{L2}}{A} \sqrt{2gh_2} \\ Q_{N3} &= V_{N3} \frac{S_{N3}}{A} \sqrt{2gh_3} \end{aligned} \quad (3)$$

S_{i3} , S_{L1} , S_{L2} , and S_{N3} are area of cross-section of valves and A is the area of cross-section of each tank. All the tanks are identical. Eq(1) is the continuous model of the system. The output of the system is the height of the liquid in each tank. Denoted as:

$$y_1 = h_1, y_2 = h_2, y_3 = h_3. \quad (4)$$

The discrete part of the system can be modeled by defining three binary variables and defining the logic statements associated with each binary variable. The three binary variables represent the three on-off valves in the system. The following logic statements can be defined depending on the valve positions.

$$\begin{aligned} 1: & h_1 \geq x_1 \wedge h_2 \geq x_2 \wedge h_3 \geq x_3 \rightarrow v_1 = 1 \wedge v_2 = 1 \wedge v_3 = 1 \\ 2: & h_1 \geq x_1 \wedge h_2 \geq x_2 \wedge h_3 < x_3 \rightarrow v_1 = 1 \wedge v_2 = 1 \wedge v_3 = 0 \\ 3: & h_1 \geq x_1 \wedge h_2 < x_2 \wedge h_3 \geq x_3 \rightarrow v_1 = 1 \wedge v_2 = 0 \wedge v_3 = 1 \\ 4: & h_1 \geq x_1 \wedge h_2 < x_2 \wedge h_3 < x_3 \rightarrow v_1 = 1 \wedge v_2 = 0 \wedge v_3 = 0 \\ 5: & h_1 < x_1 \wedge h_2 \geq x_2 \wedge h_3 \geq x_3 \rightarrow v_1 = 0 \wedge v_2 = 1 \wedge v_3 = 1 \\ 6: & h_1 < x_1 \wedge h_2 \geq x_2 \wedge h_3 < x_3 \rightarrow v_1 = 0 \wedge v_2 = 1 \wedge v_3 = 0 \\ 7: & h_1 < x_1 \wedge h_2 < x_2 \wedge h_3 \geq x_3 \rightarrow v_1 = 0 \wedge v_2 = 0 \wedge v_3 = 1 \\ 8: & h_1 < x_1 \wedge h_2 < x_2 \wedge h_3 < x_3 \rightarrow v_1 = 0 \wedge v_2 = 0 \wedge v_3 = 0 \end{aligned} \quad (5)$$

Two different configurations of the hybrid three tank system is considered here. Both the configuration is simulated in MATLAB.

III. SYSTEM CONFIGURATIONS

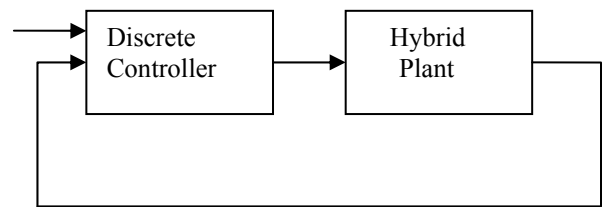

Fig. 2. Hybrid feedback control system

The hybrid feedback control system is shown in Fig. 2. The dynamics of level in each tank is continuous in nature and the position of valves is discrete in nature. Hence the plant is a hybrid plant. The plant output consists of level of liquid in the three tanks. The output is feedback to the discrete controller. The controller output controls the

closing and opening of the discrete valves and also the flow Q_1 and Q_2 .

A. Problem statement 1.

A single input single output configuration of the three tank systems is selected. The control objective is to maintain the level of the liquid in each tank at a specified value. The specified level in each tank is as follows:

- Tank 1 = 100mm
- Tank 2 = 50mm
- Tank 3 = 20mm

The hybrid model of the system for the above specification is as follows:

$$\begin{aligned} \dot{h}_1 &= \frac{1}{A} (Q_1 - Q_{13V13}) \\ \dot{h}_2 &= \frac{1}{A} (-Q_{23V23} - Q_{L2}) \\ \dot{h}_3 &= \frac{1}{A} (Q_{13V13} + Q_{23V23}) \end{aligned} \quad (6)$$

$$\begin{aligned} h_1 < x_1, h_2 < x_2, h_3 < x_3 &\rightarrow v_1 = 1, v_2 = 1, v_3 = 0, Q_1 = 0.001 \\ h_1 < x_1, h_2 \geq x_2, h_3 < x_3 &\rightarrow v_1 = 1, v_2 = 0, v_3 = 0 \\ h_1 < x_1, h_2 \geq x_2, h_3 \geq x_3 &\rightarrow v_1 = 0, v_2 = 0, v_3 = 0 \\ h_1 \geq x_1, h_2 \geq x_2, h_3 \geq x_3 &\rightarrow v_1 = 1, v_2 = 1, v_3 = 1 \\ h_1 \geq x_1, h_2 \geq x_2, h_3 \geq x_3 &\rightarrow v_1 = 0, v_2 = 0, Q_1 = 0 \\ h_1 < x_1, h_2 \geq x_2, h_3 \geq x_3 &\rightarrow v_1 = 0, v_2 = 0, Q_1 = 0.001 \\ h_1 \geq x_1, h_2 \geq x_2, h_3 < x_3 &\rightarrow v_1 = 1, v_2 = 0, Q_1 = 0 \\ h_1 < x_1, h_2 \geq x_2, h_3 < x_3 &\rightarrow v_1 = 1, v_2 = 0, Q_1 = 0.001 \\ h_1 \geq x_1, h_2 < x_2, h_3 \geq x_3 &\rightarrow v_1 = 0, v_2 = 1, Q_1 = 0 \\ h_1 < x_1, h_2 < x_2, h_3 \geq x_3 &\rightarrow v_1 = 0, v_2 = 1, Q_1 = 0.001 \\ h_1 \geq x_1, h_2 < x_2, h_3 < x_3 &\rightarrow v_1 = 1, v_2 = 1, Q_1 = 0 \\ h_1 < x_1, h_2 < x_2, h_3 < x_3 &\rightarrow v_1 = 1, v_2 = 1, Q_1 = 0.001 \end{aligned} \quad (7)$$

Eq. (6) describes the continuous dynamics of the system and eq. (7) describes the discrete dynamics of the system. The discrete dynamics consists of the valve positions for different combination of the liquid levels in each tank. Eq. (6) and eq. (7) combine to form the hybrid model of the SISO system. The continuous dynamics given in eq. (6) is implemented in Simulink as shown in Fig 3.

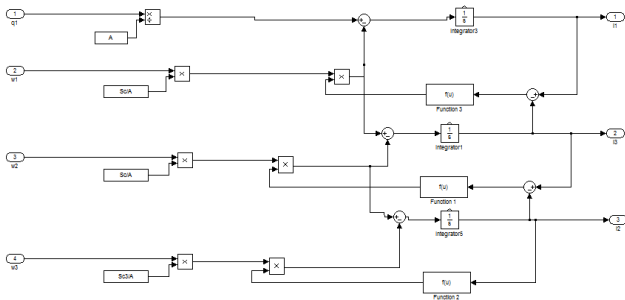

Fig.3. Simulink model for problem 1.

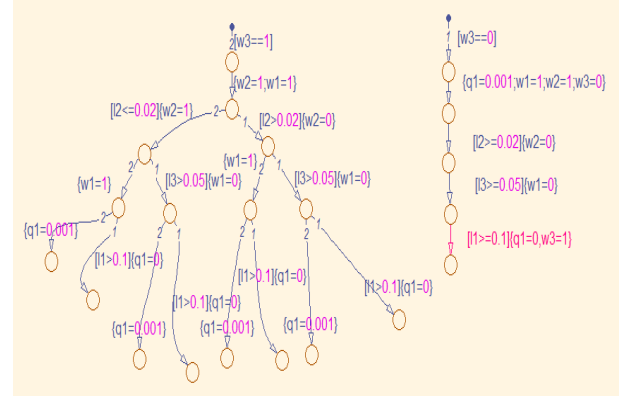

Fig.4. Stateflow model of the controller

The stateflow controller shown in fig.4. implements the discrete dynamics of the three tank system. Based on the inequality constraints of the levels of liquid in the tanks, the controller computes the value of inflow and the position of discrete valves.

B. Problem statement 2.

In this configuration of the three tank system, the level of liquid in tank 3 is to be controlled. The input flow is given to tank 1 and tank 2. The continuous and discrete dynamics of the system is given in eq. (8) and eq. (9) respectively.

$$\begin{aligned} \dot{h}_1 &= \frac{1}{A} (Q_1 - Q_{13V13} - Q_{L1}) \\ \dot{h}_2 &= \frac{1}{A} (Q_2 - Q_{23V23} - Q_{L2}) \\ \dot{h}_3 &= \frac{1}{A} (Q_{13V13} + Q_{23V23} - Q_{N3}) \end{aligned} \quad (8)$$

$$\begin{aligned} h_1 < x_1, h_2 < x_2, h_3 < x_3 &\rightarrow v_1 = 1, v_2 = 1, v_3 = 1, Q_1 = Q_2 = 0.008 \\ h_1 < x_1, h_2 \geq x_2, h_3 < x_3 &\rightarrow v_1 = 1, v_2 = 1, Q_2 = 0 \\ h_1 \geq x_1, h_3 < x_3 &\rightarrow v_1 = 1, v_2 = 1, v_3 = 1, Q_1 = 0 \\ h_1 < x_1, h_2 < x_2, h_3 \geq x_3 &\rightarrow v_1 = 0, v_2 = 0, Q_1 = Q_2 = 0.008 \\ h_1 \geq x_1, h_3 \geq x_3 &\rightarrow v_1 = 0, v_2 = 0, Q_1 = 0 \\ h_1 < x_1, h_2 \geq x_2, h_3 \geq x_3 &\rightarrow v_1 = 0, v_2 = 0, Q_1 = 0.008, Q_2 = 0 \end{aligned} \quad (9)$$

The Simulink model of the system is shown in fig. 5.

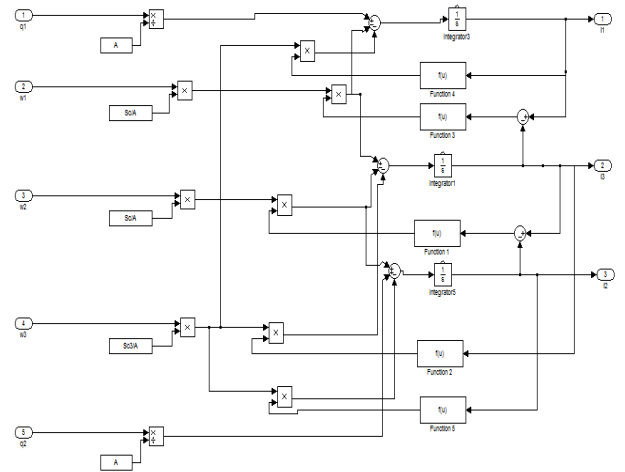

Fig. 5. Simulink model for problem 2.

The state flow controller for problem 2 is shown in fig 6.

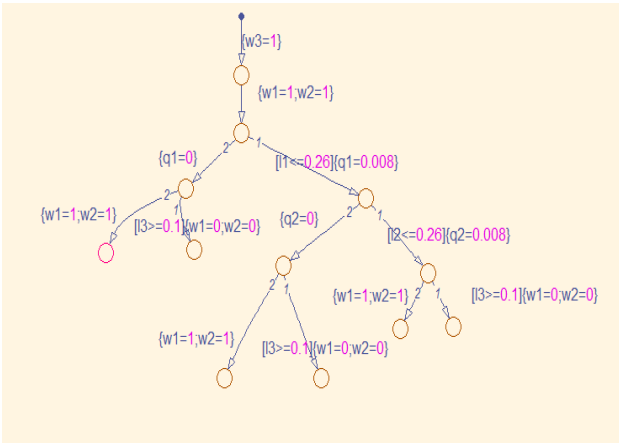

Fig. 6. stateflow controller for problem 2.

IV. RESULTS

A. Results for problem 1.

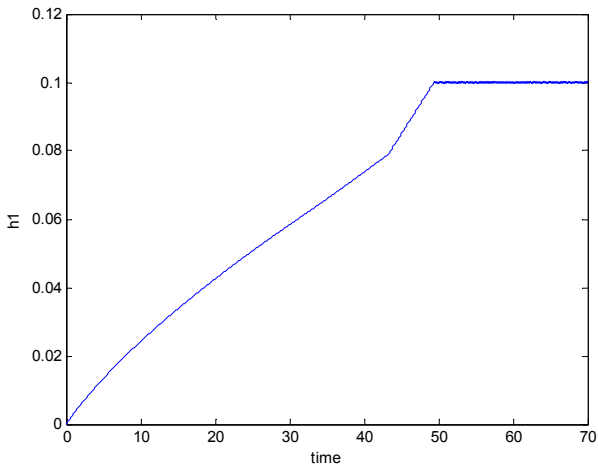

Fig. 7. Level in tank 1.

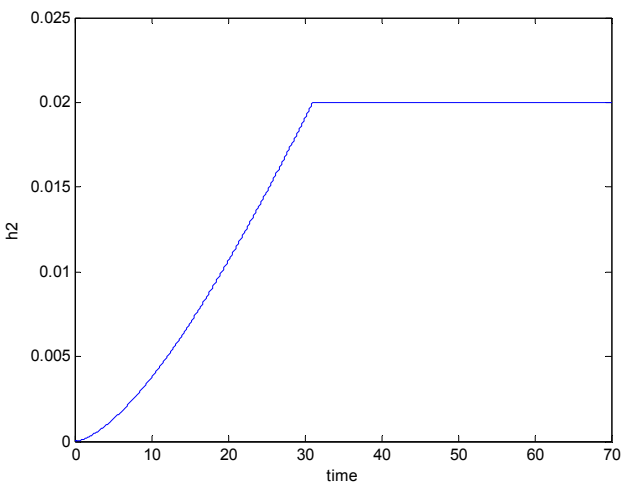

Fig. 8. Level in tank 2.

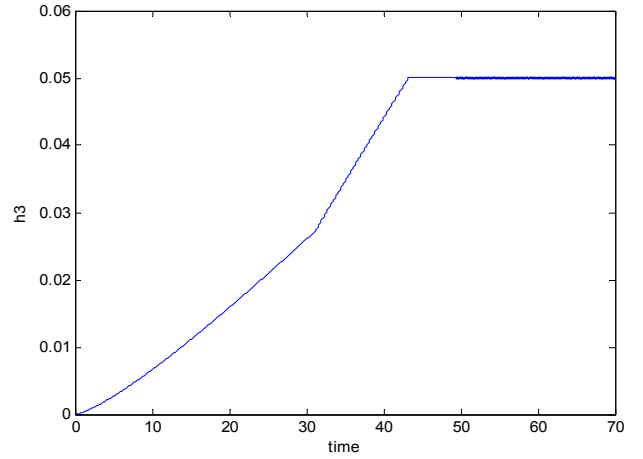

Fig. 9. Level in tank 3

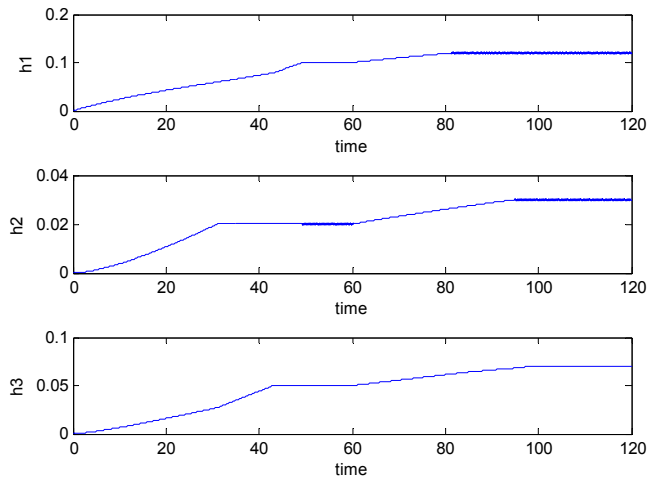

Fig. 10. Servo response for problem 1.

Fig. 7, 8 and 9 show the levels in tank 1, tank 2 and tank 3 respectively. The levels are in accordance with the given setpoints. Fig. 10 show the response of the system to a step change at the input. It is seen that the controller compensates well enough for the step change at the input.

B. Results for problem 2.

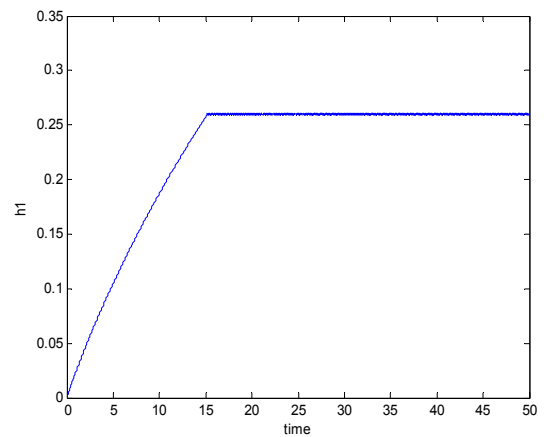

Fig. 11. Level in tank 1.

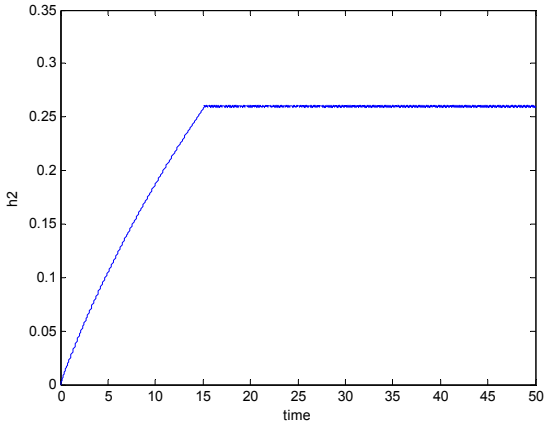

Fig. 12. Level in tank 2.

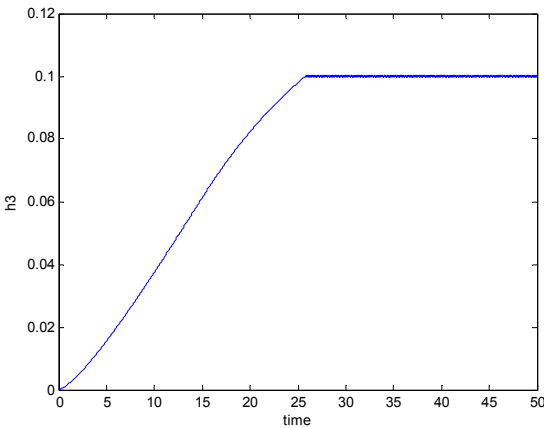

Fig. 13. Level in tank 3

Fig. 11, 12 and 13 show the levels in tank 1, tank 2 and tank 3 respectively. The levels are in accordance with the given setpoints. Fig. 14 show the response of the system to a step change at the input. It is seen that the controller compensates well enough for the step change at the input.

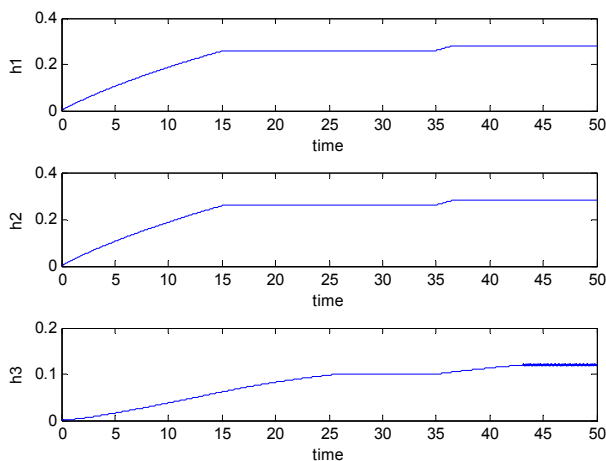

Fig. 14. Servo response for problem 2.

V. CONCLUSION

A hybrid three tank system is modeled using the hybrid modeling technique. The developed model is implemented in MATLAB using SIMULINK and STATEFLOW. STATEFLOW is used to model the discrete dynamics of the system and it implements the discrete controller for the system. Implementing controller in STATEFLOW gives rise to autonomous systems. For every other configuration of the system a new STATEFLOW controller has to be designed. This can be seen as a limitation of this approach. Methods wherein a generic form of controller is designed for all the possible configuration of the system can be investigated.

REFERENCES

- [1] A. J. Van Der Schaft, J. M. Schumacher, "An Introduction to Hybrid Dynamical Systems", Springer, 2000.
- [2] Luca Carloni, Maria D. Di Benedetto, Alessandro Pinto, Alberto Sangiovanni-Vincentelli, "Modelling Techniques, Programming Languages, Design Toolsets and Interchange Formats for Hybrid Systems", Project IST-2001-38314 COLUMBUS, March 2004.
- [3] M. Iqbal, A. I. Bhatti, Q. R. Butt, Ayub, "Controller Synthesis of a Uncertain Three Tank System Using Polytypic System Approach", Proceedings of the 17th World Congress, Seoul, Korea, July 6-11, 2008, pp. 9910-9915.
- [4] W.P.M.H. Heemels, B. De Schutter, and A. Bemporad, "On the equivalence of classes of hybrid dynamical models," Proceedings of the 40th IEEE Conference on Decision and Control, Orlando, Florida, 364-369, Dec. 2001.
- [5] R. Alur, T. Dang, J. Esposito, Y. Hur, F. Ivancic, V. Kumar, I. Lee, P. Mishra, G. J. Pappas, and O. Sokolsky. "Hierarchical modeling and analysis of embedded systems", Proceedings of the IEEE, November, 2002.
- [6] P. J. Mostermann, J. Sztipanovits, and S. Engell., "Computer automated multiparadigm modeling in control systems technology", IEEE Trans. Control Syst. Technol., 12(2):223-234, 2004.
- [7] Luca Carloni, Maria D. Di Benedetto, Alessandro Pinto, Alberto Sangiovanni-Vincentelli, "Modelling Techniques, Programming Languages, Design Toolsets and Interchange Formats for Hybrid Systems", Project IST-2001-38314 COLUMBUS, March 2004.
- [8] Jan Lunze, "Handbook of Hybrid Systems Control, Theory, Tools, Applications", Cambridge University Press, 2009.