

## Position and Temperature Detector for Autism Spectrum Disorder Children based on Sensor and Using IoT System

Yunidar Yunidar<sup>a,\*</sup>, Melinda Melinda<sup>a</sup>

<sup>a</sup> Department of Electrical and Computer Engineering, Faculty of Engineering, Universitas Syiah Kuala, Banda Aceh, 23111, Indonesia

Corresponding author: \*yunidar@usk.ac.id

**Abstract**—Children with Autism Spectrum Disorder (ASD) have characteristics where one cannot control emotions, which can cause tantrums that can impact behavior and body temperature. Based on this, they should be supervised by parents/relatives. To reduce the effects of these circumstances, this study seeks to design a technology system that can measure body temperature and detect the position of ASD children who can later monitor the activities they do. This system applies the ESP32 microcontroller and utilizes the GPS module to read the position of objects detected by the system and the MLX90614 temperature sensor, which can detect the body temperature of ASD children. Then, to facilitate checking, the control system is designed with an IoT system through the Blyn application to make it easier for users to supervise ASD children and can be accessed via smartphones in real time. In this study, detection testing was carried out on 3 ASD child subjects by grouping three conditions: namely, the child exits the location when the child is outside the predetermined location; then the child exits the body temperature when the child's body temperature is abnormal, and the child exits the location and body temperature outside normal. The results obtained show that the detector test results provide notifications to application users in the form of "child out of location," "child out of body temperature," and "child out of location and body temperature outside normal."

**Keywords**—Autism spectrum disorder; supervised; notification; IoT system.

Manuscript received 18 Aug. 2023; revised 19 Sep. 2023; accepted 3 Nov. 2023. Date of publication 31 Dec. 2023. IJASEIT is licensed under a Creative Commons Attribution-Share Alike 4.0 International License.



### I. INTRODUCTION

Children with Autism Spectrum Disorders (ASD) generally have physical, mental, social, and emotional abnormalities in growth and development [1]. Statistical data for 2018 shows 2 to 10 new cases per 1000 population. Based on data from the Population Statistics Agency (PSA) in 2010, Indonesia's population was 237.5 million, with a growth rate of 1.14%. Therefore, there are 2.4 million people with ASD in Indonesia, with a rate of adding new people up to 500 people per year [2]. ASD children can be classified into several categories, i.e., ASD children with physical disorders, ASD children with emotional or behavioral disorders, and ASD children with intellectual disabilities (autism, ADHD, Down syndrome, multiple disorders, slow learning, particular learning difficulties, and gifted) [3].

Generally, ASD Children experience body temperature outside normal conditions when the body temperature is greater than 33-36°C [4]. The biggest challenge in ASD children is the frequent occurrence of tantrums or emotional shocks. Tantrums in ASD children represent the way of

asking, refusing, or feeling uncomfortable with excessive stimulation. It can be a hysterical cry, a scream, rolling on the floor, or banging a head against the wall. This condition is a concern when the body temperatures of ASD children exceed the normal conditions (i.e., <33-36°C) [5]. The temper tantrum behavior includes banging on the wall, banging his head against the wall, running around, throwing objects around him, and other dangerous activities.

Various studies have been conducted to minimize the risk of tantrums; one of them is the design of a system for monitoring the development of children with ASD [6]. As studied by [7] developed a microcontroller-based Autistic Child monitoring tool. However, this research has drawbacks, as the vibration sensor and LM35 sensor always require voltage. Moreover, research [8] developed an android-based location detection tool for People with Autism, Dementia, and Alzheimer's. However, the tool has not been able to operate in an Android application that can only receive text messages. The next development of smart devices is in the form of belts, watches, or pendants. Microcontrollers (PIC-16F876A), global positioning systems (GPS), global systems for mobile

(GSM), and switching units and monitoring units, including sensors and mobile devices in the hands of parents, can locate children using Google Maps [9]. In addition, the smart locator can only detect the child's location and cannot recognize the condition of the patient body.

This research is experimented on children with autism, where they can walk alone without the knowledge of the guard. It is hazardous for them. The sensors we use have GPS to detect location. Body temperature sensors are also applied like previous research and supported by the internet. Then, we connect all detection sensors into a single unit in an application called Blynk so that the guard can monitor it.

The main contributions of this paper are as follows:

- a. This study develops a tantrum detection device that can read the location and control the body condition of ASD children, and caregivers of ASD children were defined as users.
- b. This detector is equipped with a temperature detection feature so that users can predict a tantrum condition for autistic children will occur.
- c. Utilizing IoT as an output that can provide SMS notifications to stored contact numbers, namely ASD children users, in the form of subject locations obtained from GPS and temperatures detected by sensors on the device

The application of technology in overcoming problems in ASD children with tantrum conditions can injure them in their conscious state, so a prototype is needed that can detect the location and body temperature of ASD children.

## II. MATERIAL AND METHOD

The material of this system can detect the position of the ASD child and can predict the condition of the body in tantrums or average temperatures based on sensors. Sensors are objects used to detect physical or chemical changes, which have outputs in the form of variables converted into electrical quantities [10]. Sensors are needed in systems that work automatically, with sensor data in the form of information that will continue to be processed by the microcontroller. Thus, the system can work according to its commands [11].

### A. Hardware Details

In this study, three different location coordinates were used, namely The Darul Falah Street in Pineung Village, Banda Aceh, Prada Utama Street in Lamugop, Banda Aceh, and Krueng Barona Jaya Football Field Street in Aceh Besar, Indonesia. Figure 1 shows the components used for the prototype design. The prototype tantrum detector design is rectangular, including a belt, as shown in Fig. 1. Design specifications Length x width x height is 14 cm x 9 cm x 4 cm. The materials are MLX90614 sensor, GPS Ublox Neo-6M, microcontroller ESP 32, dan SIM800L. To access data through an IoT system-based Blynk application.

ESP 32 is a microcontroller based on the ESP 8266 module, a board module that can be connected to a microcontroller [12]. ESP 32 is suitable for projects that use the IoT concept because WIFI and Bluetooth modules are available [13], [14]. In this study, ESP32 is used to store measurement data from devices such as sensors and will be sent to users continuously via mobile devices or the internet [15].

MLX90614 Temperature Sensor is used as a temperature gauge and an infrared thermometer without contact with the object surface (non-contact) to obtain high-accuracy measurements [16]. With an accuracy level of  $-40^{\circ}\text{C}$  to  $125^{\circ}\text{C}$  for ambient temperature and  $-70^{\circ}\text{C}$  to  $380^{\circ}\text{C}$  for object temperature with standard accuracy of  $\pm 0.5^{\circ}\text{C}$  around room temperature. Accuracy of  $\pm 0.2^{\circ}\text{C}$  in a limited temperature range around human body temperature has been offered to special versions for existing medical applications [17]. This temperature sensor comprises a temperature-sensitive detector chip using infrared [18]. The sensor is also supported by a 17-bit ADC and calibrated thermometer with digital output from PWM. The 10-bit PWM standard will show temperature changes with the temperature range on the sensor if measured continuously [19]. This sensor can work with a wide measuring range from  $-70^{\circ}\text{C}$  to  $+380^{\circ}\text{C}$ . Figure 3 shows an MLX 90614 temperature sensor [20].

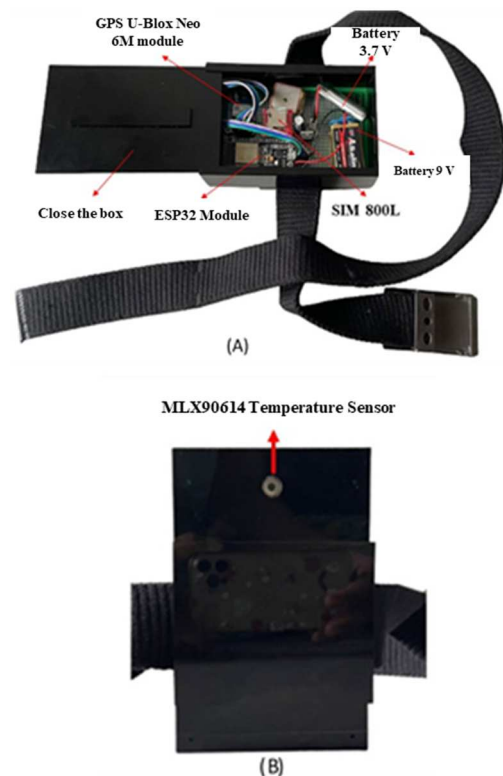

Fig. 1 The proposed tantrum detector (a) Hardware design (b) Temperature sensor design

In this study, the MLX90614 sensor is used to detect the temperature of ASD children on the back of the box. The temperature was detected at the back of the waist with an accuracy of 6 cm because the MLX sensor works non-contact. The sensor reading results are from degree readings sent to the Blynk application. The data generated by the GPS module and temperature sensor is processed by the ESP32 microcontroller and sent to the Blynk user using the SIM800L module as an internet module that supports the IoT system.

The UBLOX Neo 6M GPS module aims to detect the location of ASD children. The UBLOX Neo 6M GPS module will send the location coordinates in the form of latitude and longitude points and then be displayed on the Blynk user application [21]. The U-Blox Neo GPS module can be used for navigation [22]. Determination of the location of this

module using the distance resection method to several satellites. This module also features the best chip, Power Save Mode (PSM), which can reduce system power consumption by selectively switching the receiver on and off [23], [24].

The GSM SIM800L module aims to send data containing emergency messages and location data to the recipient automatically [25]. The working principle is that the data processed on the ESP 32 is sent using the data path on the TX pin of the ESP 32 to embed RX in the SIM800L [26], [27]. Due to the voltage drop from Arduino, the voltage source is replaced with a 9V battery, and data from the ESP 32-pin Tx is connected to a DC-to-DC step-down converter, which is connected to Rx SIM800L [28].

### B. Software of IoT System

At the stage of software utilization in this study, the Internet of Things (IoT)-based software, namely Arduino Integrated Development Environment (IDE), has been installed [29]. Arduino IDE is software used as a programmer for various Arduino devices. Arduino IDE software uses the C or C++ programming language. The Arduino Software (IDE) does not just make it easy to write code and upload it to the board. Arduino IDE can work on Windows, Mac OS X, and Linux. Environment written in Java Language and based on processing and other open source software. Library installation is carried out using the MLX90614 sensor device, Ublox Neo 6M GPS device, ESP32, and Blynk application to run the system program. The library can be downloaded on the Arduino Library website. For the ESP-32 Library, use the Arduino IDE software directly. Each input's programming and algorithm design in the form of sensors and GPS produces output outputs as actuators or statements in the notification Blynk [30] (e.g., Fig. 2).

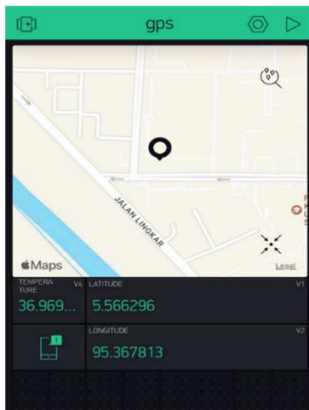

Fig. 2 Blynk Mockup Display

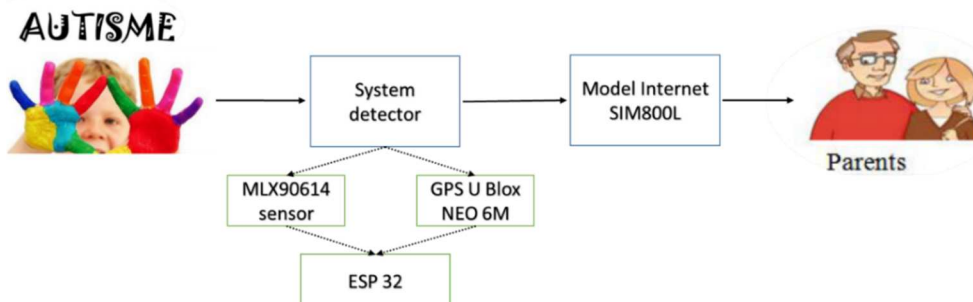

Fig. 4 IoT work system in detecting the position and body temperature of ASD children

The use of the Blynk application begins with a new project created on the Blynk application installed on a smartphone. Then, determine the project's name, namely MLX90614, GPS Ublox Neo 6M, and SIM800L, using ESP32 devices and connected to GSM. After the project is completed, it will get an Auth Token on the email used as an account when initially registering. The Auth Token will be used on the Arduino IDE when writing programs. This stage will be completed when the hardware program or hardware can work and can function according to the algorithm that has been designed. The algorithm generated by the software system can be seen in Fig. 3.

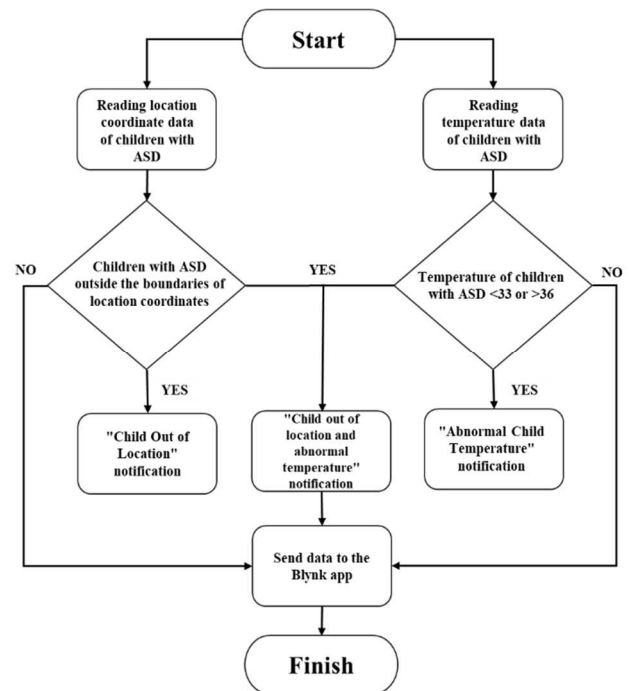

Fig. 3 Software System Algorithm Flow Diagram

Based on Fig. 3, software utilization works by inputting data from temperature sensors and GPS modules. If the ASD child goes out of the coordinate limit and normal temperature limit set in the programming algorithm, a notification will appear to the user. Otherwise, the temperature data measured by the sensor and the coordinate points read by the GPS module will still send the information automatically to the user's smartphone through the Blynk application. Illustration of the use of IoT systems in detecting the position and body temperature of children with ASD is shown in Fig. 4.

### III. RESULT AND DISCUSSIONS

#### A. MLX90614 Sensor Testing

Testing the accuracy of the MLX90614 temperature sensor is carried out by comparing the measurement value from the sensor with measurements using a manual measuring instrument with a non-contact way of working, namely the Thermometer gun. The thermometer gun was placed on the back of the waist of 10 samples. Measurements were carried out at the same distance of 4 cm, and the sensor and thermometer gun data were taken simultaneously. Table I shows the test data for the MLX90614 temperature sensor.

TABLE I  
THE TEST DATA FOR THE MLX90614 TEMPERATURE SENSOR

No	Name	Thermometer Gun (°C)	Font Type Measurement		Average	% Error
			1	2		
1	Sample 1	36.5	36.56	36.61	36.60	0.28 %
2	Sample 2	35.1	34.91	35.20	35.05	0.14 %
3	Sample 13	36.2	36.08	36.31	36.15	0.13 %
4	Sample 14	34.5	34.70	34.68	34.65	0.43 %
5	Sample 5	35.6	35.72	35.70	35.71	0.30 %
6	Sample 6	36.0	35.96	36.10	36.03	0.08 %
7	Sample 7	35.4	35.29	35.31	35.30	0.28 %
8	Sample 8	34.9	35.18	35.20	35.19	0.83 %
9	Sample 19	36.2	35.89	35.95	35.92	0.77 %
10	Sample 10	34.7	34.90	34.68	34.79	0.26 %

Fig. 5 shows that in each data difference between the temperature data obtained with the MLX90614 sensor and the thermometer gun, there is no high difference or hummed together. However, the temperature data using a thermometer gun, samples 8 and 9, obtained a difference with an error of 0.835% and 0.77%, respectively. This is due to the movement at the time of measurement at the waist.

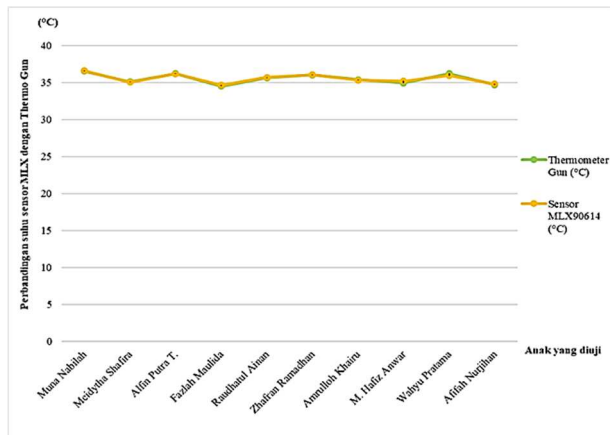

Fig. 5 Comparison of MLX90614 Sensor with Thermometer gun

#### B. U-Blox Neo 6M GPS Testing

U-Blox Neo 6M GPS module testing is done by comparing the Longitude coordinates and the GPS module's magnitude with Google Maps on a smartphone. The test was carried out with two different scenarios: indoors (building) and outdoors the building. This test aims to determine the accuracy of the data generated by the GPS module by comparing data from similar sources.

Figure 6 shows the difference in distance between the data from the test coordinates determined using Google Maps

using Euclidean distance. Euclidean distance is an error measurement standard for the GPS module to compare the coordinates read using the U-Blox Neo 6M GPS module. The GPS module will determine the location of the prototype's longitude and latitude coordinates. Latitude represents longitude, and longitude is latitude. The GPS module was tested at 4 locations, as shown in Table II.

TABLE II  
U-BLOX NEO 6M GPS MODULE ACCURACY TESTING WITH GOOGLE MAPS

No	Location	Google Map Testing Latitude Longitude	GPS UBlox Neo Testing Latitude Longitude	Distance A (m)	Distance B (m)	Difference (m)
1	Electrical Engineering Electronics Lab	5.56653795.36796	5.5654195.3558	1	0.001641	0.9
2	Basketball Court (Faculty of Engineering)	5.56746195.36920	5.5662295.3471	1	0.001237	0.9
3	Canteen (Faculty of Engineering)	5.56794995.36919	5.5557095.0381	1.5	0.001357	1.4
4	Home outdoors (Housing area of MBR H9)	5.58574495.36519	5.5757195.2041	2.5	0.001146	2.4
Average						14

The test results show that the average distance comparison between A and B is 1.4 m. Based on the distance difference in the tests, the tool works optimally outdoors, such as in the field and high-rise buildings. The GPS module obtains location information signals from satellite signals.

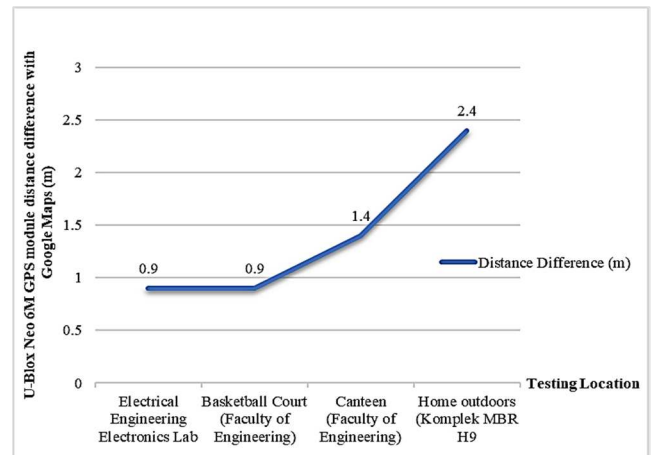

Fig. 6 U-Blox Neo 6M GPS module distance difference with Google Maps

The satellite signal is difficult to obtain in experiments with a high distance difference because obstructions hamper it. To get good results, the tool is operated at outdoor temperatures or where the barrier is minimal to get a reflection or reflection from the satellite signal so that the GPS module can easily receive it.

#### C. SIM 800L Module Testing

The SIM 800L module is tested by installing a SIM card on a smartphone device. It is useful for sending data from the



sensor to the Blynk application cloud. To run this tool requires a supply voltage of 3.7 volts. This voltage corresponds to the dataset, and the LED on the top right side of the GSM SIM800L module indicates the status of the cellular network. This LED flashes with different levels to indicate the temperature; if it flashes once every 1 second, this module is running but not yet connected to the cellular network. If it flashes every 2 seconds, then GPRS data is active, and if the LED flashes once every 3 seconds, it has made contact with the mobile network and can send/receive voice and messages. This test is done using AT COMMAND.

Figure 7 shows that the SIM module can send data to Blynk and the notification received by the user, as shown in Fig. 8. If the SIM800L Module is ready for use on the COM3 monitor, a "Modem in" notification will appear. If the SIM800L Module is not connected, a "Modem cannot in" message will appear. Testing can also be done by calling the cellular number from the SIM card if the phone rings/incoming. It means that SIM800L can send data to "Blynk."

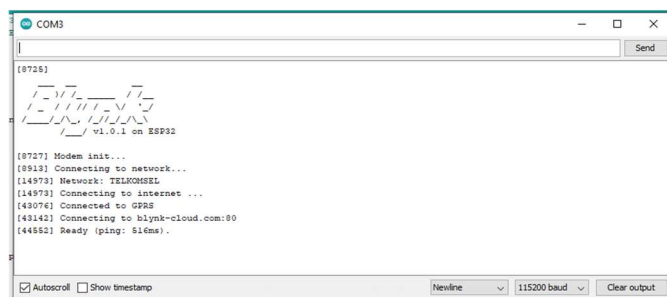

Fig. 7 The test results for the GSM SIM 800L module

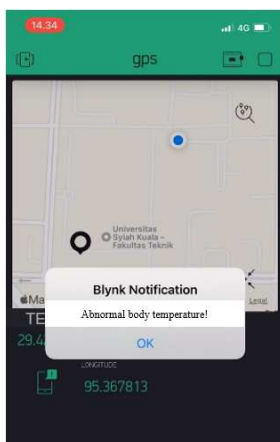

Fig. 8 Display notification of ASD child condition in Blynk application through IoT

#### D. Detector Testing

After testing the accuracy of the prototype components, ASD children were tested using three different locations. This prototype will be attached to the body of ASD children and will measure body temperature and detect the location coordinates (e.g., Fig. 9). The user will receive a notification if the ASD children produce a temperature outside the normal temperature limit and out of the coordinates of the monitoring location set in the Arduino IDE program. This detector measures body temperature and reads location coordinates from the location of ASD children, showing the Blynk user interface (e.g., Fig. 10).



Fig. 9 Prototype implementation process

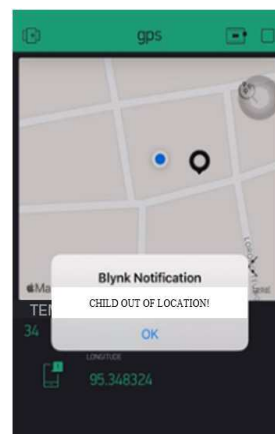

(a)

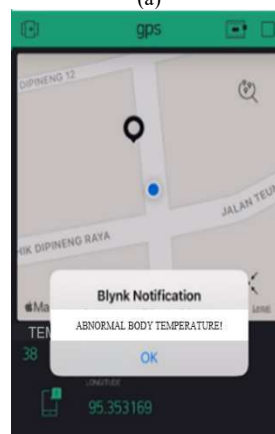

(b)

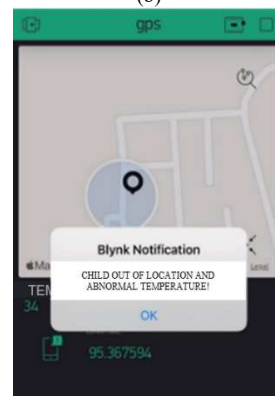

(c)

Fig. 20 Blynk user interface (a) position notification (b) body temperature notification (c) position and body temperature notification

The measurement value obtained is processed by the ESP32, which is sent to the Blynk user using SIM800L. There are 3 kinds of measurement value notification displays, namely, "children out of location," meaning the child is in a normal temperature state but is out of the coordinates of the specified location, both "children's temperature is not normal," meaning the child is in the location but in a state of the temperature outside the normal body temperature and the third "children outside the location and the temperature is not normal" means the child is outside the coordinate point and in a temperature outside the normal condition, in the third

notification condition the user is in a state of alert for tantrums in children with special needs because the child is outside the normal temperature and is out of control.

This detector can be monitored remotely if the user is outside the coordinates. The user can still supervise children with special needs. This system only requires the Blynk application and logging in to the account that has been created. This system is very helpful for users in supervising children with special needs easily and in real-time. The results of the tantrum detector test are shown in Table III.

TABLE III  
THE RESULTS OF THE TANTRUM DETECTOR TEST

Child Age	Test Location (Latitude and Longitude)	Measurement	Body Temperature (°C)	GPS Coordinates		Notifications
				Latitude	Longitude	
Child 1 Age 16 Years (Girl)	The Darul	1	32	5.567305	95.34834	Children outside the location and abnormal temperature
	Falah Street in Pineung	2	35	5.567501	95.34807	Children outside the location
	Village, Banda Aceh,	3	34	5.567501	95.34807	Children outside the location,
	(5.567186,	4	36	5.567336	95.34814	Children outside the location
	95.348046)	5	37	5.567482	95.34812	Children outside the location, and abnormal temperature
Child 2 Age 7 Years (Boy)	Prada Utama	1	36	5.5663	95.35323	Children outside the location
	Street in	2	37	5.5663	95.35329	Children Outside the Location and abnormal temperature
	lamgugop	3	34	5.567501	95.34807	Children outside the location
	Banda Aceh,	4	37	5.566429	95.35329	Children outside the location and abnormal temperature
	(5.566564	5	38	5.566564	95.35316	Abnormal temperature

Based on Table III, the tests were carried out on 3 ASD children with different locations. The test was repeated 5 times on each subject with a time lag of 8 minutes for each test. The first test is on Darul Falah Street in Pineung Village, Banda Aceh, with coordinates of 5.567186 and 95.348046. In Child 1, the body temperature is unstable. It does a lot of movement so that the notification is "child outside the location" and "child outside the location and the temperature is outside normal".

The second test was on Prada Utama Street in Lamgugop 5 times with the latitude and longitude coordinates of 5.566564; and 95.353169. In Child 2, the body temperature is high >36 C, which is outside normal, and Child 2 is in a state of 2 notifications "children outside the location", 2 notifications "children outside the location and temperature is not normal," and 1 notification "temperature is not normal".

The third test was on Krueng Barona Jaya Football Field Street in Aceh Besar, Indonesia with coordinates 5.555630 and 95.367667. Based on the test results, Child 3 has a low body temperature or <33 C, which is outside the normal temperature, and Child 3 is in a state of 2 notifications "body temperature is outside normal" and 3 notifications "child is out of location and body temperature is outside normal".

#### E. Comparison of System Detector Result

Based on the results of this study, it can be compared with previous studies that made prototypes in the form of belts [7]. This study used different components, namely the U-Blox Neo 6M GPS to read the position and the MLX90614 sensor

to measure the temperature of children with ASD. For information systems in this study, apply IoT systems through the Blynk application. This can help users in knowing body position and temperature better than previous studies [9].

TABLE IV  
PERFORMANCE COMPARISON SEVERAL METHOD OF DETECTOR

Method	System Detector			Ref.
	Position	Body temperature	IoT System	
Microcontroller, GPS, GSM using Google Map.	√	√	-	[7]
GPS sensor and based on IoT System	√	-	√	[9]
Proposed method	√	√	√	

Table IV compares the performance of several system detector methods referenced in this study. Our research shows that the proposed method, which can detect position body temperature based on IoT systems, has been developed from the previous system.

#### IV. CONCLUSION

Based on the measurement of the MLX90614 sensor used in this study, it is stated that it can adjust the measurement results using a gun thermometer as long as there is no interference when measuring. A position and temperature of

ASD children detector based on IoT has been successfully designed. This prototype ASD children detector was developed as a belt box and can transmit real-time data without distance limitations. Users use the IoT application by utilizing the Blynk application to supervise ASD children easily. However, the GPS module can be used as a faster and more accurate module in obtaining coordinate points without being blocked by signals, and the prototype display or case can be improved to be more wearable to increase comfort in children with special needs. This research can also be developed by adding algorithms that can determine the condition of children in a tantrum or normal.

#### NOMENCLATURE

##### Subscripts

GPS	Global Positioning System
IoT	Internet of Thing
ASD	Autism Spectrum Disorders
GSM	Global System for Mobile
ESP	Enhance Smart Power
SMS	Short Message Service

#### ACKNOWLEDGMENT

We thank all parties who support this study.

#### REFERENCES

- [1] U. A. Siddiqui *et al.*, "Wearable-sensors-based platform for gesture recognition of autism spectrum disorder children using machine learning algorithms," *Sensors*, vol. 21, no. 10, 2021, doi: 10.3390/s21103319.
- [2] World Autism Awareness Day: Recognize the Symptoms, Understand the Situation. [Online]. Available: <https://www.kemenpppa.go.id/index.php/page/read/31/1682>
- [3] T. Ghosh *et al.*, "Artificial intelligence and internet of things in screening and management of autism spectrum disorder," *Sustain. Cities Soc.*, vol. 74, p. 103189, 2021, doi: 10.1016/j.scs.2021.103189.
- [4] S. Kimura, Y. Takaoka, M. Toyoura, S. Kohira, and M. Ohta, "Core body temperature changes in school-age children with circadian rhythm sleep-wake disorder," *Sleep Med.*, vol. 87, pp. 97–104, 2021, doi: 10.1016/j.sleep.2021.08.026.
- [5] S. Erden, "Hypothermia Associated with Melatonin Ingestion in a Child with Autism," *Clin. Neuropharmacol.*, vol. 42, no. 5, pp. 179–180, 2019, doi: 10.1097/WNF.0000000000000355.
- [6] M. T. Tomczak *et al.*, "Stress monitoring system for individuals with autism spectrum disorders," *IEEE Access*, vol. 8, 2020, doi: 10.1109/ACCESS.2020.3045633.
- [7] N. Nigar, "Microcontroller based autistic child monitoring system in Bangladesh," *J. Kejuruter.*, vol. 33, no. 1, pp. 83–88, 2021, doi: [https://doi.org/10.17576/jkukm-2020-33\(1\)-09](https://doi.org/10.17576/jkukm-2020-33(1)-09)
- [8] V. Khullar, H. P. Singh, and M. Bala, "Meltdown/Tantrum Detection System for Individuals with Autism Spectrum Disorder," *Appl. Artif. Intell.*, vol. 00, no. 00, pp. 1–25, 2021, doi: 10.1080/088839514.2021.1991115.
- [9] R. Aisuwarya, Melisa, and R. Ferdian, "Monitoring and Notification System of the Position of a Person with Dementia Based on Internet of Things (IoT) and Google Maps," *ICECOS 2019 - 3rd Int. Conf. Electr. Eng. Comput. Sci. Proceeding*, pp. 396–400, 2019, doi: 10.1109/ICECOS47637.2019.8984591.
- [10] K. Deo, R. Deedwania, and S. Bairagi, "Human Intrusion and Motion Detection System," *Int. J. Comput. Appl.*, vol. 176, no. 28, pp. 46–49, 2020, doi: 10.5120/ijca2020920315.
- [11] M. Jafarzadeh, S. Brooks, S. Yu, B. Prabhakaran, and Y. Tadesse, "A wearable sensor vest for social humanoid robots with GPGPU, IoT, and modular software architecture", vol. 139. 2021. doi: 10.1016/j.robot.2020.103536.
- [12] A. Imran, M. Yantahin, A. M. Mappalotteng, and M. Arham, "Development of Monitoring Tower Using Gyroscope Sensor Based on Esp32 Microcontroller," *J. Appl. Eng. Technol. Sci.*, vol. 4, no. 1, pp. 405–414, 2022, doi: 10.37385/jaets.v4i1.1327.
- [13] A. Ghodake, S. Gomase, J. Omkar, and S. Aswale, "Design and Implementation of Women Safety System Based On IOT Technology," *Int. Res. J. Eng. Technol.*, vol. 08, no. 06, pp. 1258–1261, 2021. [Online]. Available: [www.irjet.net](http://www.irjet.net)
- [14] V. Baby Shalini, "Smart Health Care Monitoring System based on Internet of Things (IoT)," *Proc. - Int. Conf. Artif. Intell. Smart Syst. ICAIS*, pp. 1449–1453, 2021, doi: 10.1109/ICAIS50930.2021.9396019.
- [15] D. Iskandar, E. W. Nugroho, D. Rahmawati, and I. Rozikin, "Automatic Door Control System with Body Temperature Sensor," *Int. J. Comput. Inf. Syst.*, vol. 2, no. 4, pp. 111–114, 2021, doi: 10.29040/ijcis.v2i4.42.
- [16] A. Sudianto, Z. Jamaludin, A. A. Abdul Rahman, S. Novianto, and F. Muharrom, "Smart Temperature Measurement System for Milling Process Application Based on MLX90614 Infrared Thermometer Sensor with Arduino," *J. Adv. Res. Appl. Mech.*, vol. 72, no. 1, pp. 10–24, 2020, doi: 10.37934/aram.72.1.1024.
- [17] R. W. Tareq and T. A. Khaleel, "Implementation of MQTT Protocol in Health Care Based on IoT Systems: A Study," *Int. J. Electr. Comput. Eng. Syst.*, vol. 12, no. 4, pp. 215–223, 2021, doi: 10.32985/IJECES.12.4.5.
- [18] C. Khandekar, W. Jin, and S. Fan, "Direct thermal infrared vision via nanophotonic detector design," 2021, [Online]. Available: <http://arxiv.org/abs/2108.11583>.
- [19] D. A. Setiawati, S. G. Utomo, Murad, and G. M. D. Putra, "Design of temperature and humidity control system on oyster mushroom plant house based on Internet of Things (IoT)," *IOP Conf. Ser. Earth Environ. Sci.*, vol. 712, no. 1, 2021, doi: 10.1088/1755-1315/712/1/012002.
- [20] P. W. A. Sucipto and A. Firasanti, "Internet-Based Multi-Platform Thermometer Using WhatsApp and Sensor MLX90614 with Location Tracker Feature for Covid-19 Surveillance," *Proc. 2nd Borobudur Int. Symp. Sci. Technol. (BIS-STE 2020)*, vol. 203, pp. 39–45, 2021, doi: 10.2991/aer.k.210810.008.
- [21] D. Hercog, T. Lerher, M. Truntič, and O. Težak, "Design and Implementation of ESP32-Based IoT Devices," *Sensors*, vol. 23, no. 15, 2023, doi: 10.3390/s23156739.
- [22] Y. E. Windarto, B. M. W. Samosir, and M. R. Assariy, "Internet of Things-Based Room Monitoring Using Thingsboard and Blynk," *Walisono J. Inf. Technol.*, vol. 2, no. 2, p. 145, 2020, doi: 10.21580/wjit.2020.2.2.5798.
- [23] J. Piriataravet, W. Kumwilaisak, J. Chinrungrueng, and T. Piriayatharawet, "Determining bus stop locations using deep learning and time filtering," *Eng. J.*, vol. 25, no. 8, pp. 163–172, 2021, doi: 10.4186/ej.2021.25.8.163.
- [24] Yosef Doly Wibowo, "Implementation of the Ublox 6M GPS Module in the Design and Development of an Internet of Things-Based Motorcycle Security System," *Electrician*, vol. 15, no. 2, pp. 107–115, 2021, doi: 10.23960/elc.v15n2.2173.
- [25] P. Kanani and M. Padole, "Real-time Location Tracker for Critical Health Patient using Arduino, GPS Neo6m and GSM Sim800L in Health Care," *Proc. Int. Conf. Intell. Comput. Control Syst. ICICCS 2020*, no. *Iciccs*, pp. 242–249, 2020, doi: 10.1109/ICICCS48265.2020.9121128.
- [26] A. R. Yanes, P. Martinez, and R. Ahmad, "Towards automated aquaponics: A review on monitoring, IoT, and smart systems," *J. Clean. Prod.*, vol. 263, pp. 1–21, 2020, doi: 10.1016/j.jclepro.2020.121571.
- [27] S. Usha, M. Karthik, R. Lalitha, M. Jothibasu, and T. Krishnamoorthy, "Automatic Turning ON/OFF Bike Indicator Using Offline GPS Navigation System," *IOP Conf. Ser. Mater. Sci. Eng.*, vol. 1055, no. 1, p. 012032, 2021, doi: 10.1088/1757-899x/1055/1/012032.
- [28] A. Nurjannah and M. N. F. Alfata, "Prototype of automated shading device: preliminary development," *Eng. J.*, vol. 24, no. 4, pp. 229–238, 2020, doi: 10.4186/ej.2020.24.4.229.
- [29] A. Soury, M. Y. Ghafour, A. M. Ahmed, F. Safara, A. Yamini, and M. Hoseyninezhad, "A new machine learning-based healthcare monitoring model for student's condition diagnosis in Internet of Things environment," *Soft Comput.*, vol. 24, no. 22, pp. 17111–17121, 2020, doi: 10.1007/s00500-020-05003-6.
- [30] T. U. Kumar and A. Periasamy, "IoT Based Smart Farming (E-FARM) 'S T.'", vol. 2, no. 4, pp. 85–87, 2021.