

Statistical Characterization of Indian Residential Networks for Powerline Communication

Shashidhar Kasthala[#], GKD Prasanna Venkatesan^{*}, A Amudha[#]

[#]EEE Department, Karpagam University, Karpagam Academy of Higher Education, Coimbatore, 641021, India
E-mail: shashi_kb4u@rediffmail.com

^{*}SNS College of Engineering, Coimbatore, City, 641107, India
E-mail: prasphd@gmail.com

Abstract— Despite different powerline channel modeling techniques, developed so far, there are still specific dynamic, varying parameters (viz. the random load variation and inconsistent electrical wiring) to be studied for a valid and reliable power line communication (PLC) model. Statistical characterization of PLC channel may provide the required background for refinement of these existent models. In this paper, the Indian residential networks are statistically analyzed in the frequency range of 1-100 MHz. This also includes the comprehensive analysis of line impedance, stationary noise, channel capacity and average channel gain. From the measurements, the noise spectrum density is found to be less than -90 dBm at a frequency less than 1 MHz and is almost constant after 70 MHz. The minimum and maximum channel capacity of the network is 71.5 Mbps and 97.7 Mbps respectively. The Average channel gain is estimated at -30 dB. The paper also reviews the channel transfer function developed by top-down and bottom-top approaches. Finally, some additional factors influencing the PLC channel are also discussed.

Keywords— average channel gain; channel capacity; channel transfer function; line impedance.

I. INTRODUCTION

Achieving higher data rates using the power line as a communication medium is almost a reality today, thanks to the extensive research carried out till date [1]. However, there is still a long way to go in commercially deploying an efficient and reliable PLC system. The principal task towards attaining this is to understand the characteristics of power line measured regarding noise, attenuation, and impedance, which, unfortunately, vary with time, geographical position and topology of the network. These parameters can only be understood by undertaking an exhaustive study of the electrical network.

Though various channel-modeling techniques, as discussed in [2], are developed to characterize and model the power lines, there is still a need to develop a more accurate model considering the real-time scenarios. The top-down approach of channel modeling is a simple technique developed on the multipath propagation model. This model is developed based on the data obtained from the measurements and hence can be modeled for a fixed network only and cannot be generically used [3]. The bottom-top approach of channel model is a widely preferred model developed on the transmission line theory. This model can be developed only by obtaining substantial information

regarding the electrical network and thus rated as an effective but complicated model [4]. The two-port network model developed on this approach considers a few practical aspects like grounding and coupling effects [5], [6].

In this paper, the channel transfer function (CTF) of an Indian residential electrical network is measured using the vector Network analyzer and is statistically modeled. The paper also presents the channel statistics regarding average channel gain, line impedance, stationary noise and channel capacity. The CTF for the same network is also simulated using the conventional top-down and bottom-top approaches. It also discusses the factors influencing the channel transfer function. This includes the impedance due to appliances, attenuation due to loads and cross talk between the communication ports.

One important aspect need to be incorporated in the PLC channel modeling is the dynamic nature of attenuation and multipath fading. The non-continuous operation of electrical appliances leads to extreme variability in attenuation and load impedance. In addition to this, the impedance of a power line also varies with the hour of the day [7]. Using these traditional approaches, it is laborious to model such a diversified channel behavior. This problem can be addressed by characterizing the power line channel statistically [8], [9]. The statistical analysis provides a sophisticated outlook of

the powerline channel behavior regarding impedance discontinuities and attenuation of loads.

As per the literature available, statistical Characterization of power line channel, in the frequency range of 1-100 MHz, has been undertaken in Europe. In [9], the measurement campaign was carried out in Italian residences to obtain the relationship between the line impedance and Channel frequency response. In [10], the statistical analysis is carried out on France residences to compute the root-mean-square (RMS) delay spread and coherence bandwidth. The [11], the statistical modeling of the average channel gain (ACG) and RMS delay spread is evaluated on the Brazilian homes. In this paper, the procedure followed for statistical characterization is as recommended in [8]. However, due to the difference in electrical network topologies between European countries and India, the results from all the works mentioned above may not be strictly analogous with the results in this paper.

Though the work in this paper is confined to Phase-Neutral ports for analyzing the channel transfer function to obtain larger benefit. The difference in attenuation is also verified when Phase-Earth and Neutral-Earth ports are used. It is also observed that, due to the proximity of the cables and the coupling effects, there is a chance of cross talk between the different wires of the cable.

The subsequent sections of this paper are organized as follows. In Section II of this paper, the experimental setup and the methodology followed to characterize the channel is explained. The traditional channel modeling techniques are also compared in this section. In Section III, the power line channel is statistically characterized, and the factors influencing the power line channel modeling are examined.

II. MATERIAL AND METHOD

A. Experimental Setup

An experimental setup as shown in Fig. 1 is developed to measure the channel transfer function of Indian residential networks.

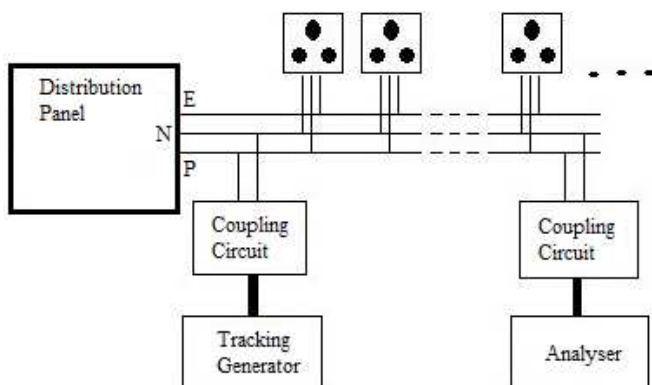

Fig. 1 Experimental setup

120 responses are acquired from 5 different flats of an apartment having single phase wiring. In a typical Indian residential building, single-phase wiring consists of Phase, Neutral, and Earth. The wiring structure in these houses is similar, but the appliances connected to the network may differ. Depending on the electrical appliance used, the wiring

cross-section may be 2.5 sq.mm or 1.5 sq.mm. However, for the ease of simulation, the entire cross-section of wire is considered as 2.5 sq.mm placed in an unsheathed flexible PVC cable.

For the measurement campaign, a capacitive-transformer coupler is connected between the power line and the measuring instrument to avoid any direct contact of the high voltage supply. Since the power line is exposed to unpredictable transients and surges, the coupler is provided with Metal Oxide Varistor. The overvoltage conditions and any other disturbances are avoided by adding a bidirectional transient voltage suppressor (TVS) on the measuring instrument side. The Electric Fast Transient/Burst Immunity test (IEC 61000-4-4) and Surge Test (IEC 61000-4-5) are conducted on the coupling circuit to verify its immunity levels.

The measurements in this paper are carried out in the frequency range of 1-100 MHz using R&S ZVL Vector Network Analyzer. The start frequency is selected as 0.5 MHz, and the stop frequency is selected as 100 MHz with 200 sweep points in between. The signal is transmitted from the tracking generator with a power level of 0 dBm. The channel transfer function of the power line is analyzed between the main distribution box and a distant socket of the network. While analyzing the measurements, the effect of the coupling circuit is eliminated by using the ABCD matrix method.

The impedance of the power line is also measured from the S parameters of the VNA and is explained in the subsequent section. The noise in the power line is measured using R&S FSL Spectrum Analyzer. The noise is measured periodically, in the frequency range of 1-100 MHz, on the network for every 15 min. The resolution band is kept at 10 kHz and 8192 sweep points.

The measurement campaign is undertaken throughout the day, with varied load configurations and different distances between the transmitter and receiver ports. The loads in these flats are the typical household appliances such as television, personal computer, light sources, refrigerator, washing machine, and printer.

B. Power Line Channel Modelling

To determine the CTF of a power line channel, various PLC channel generators, based on top-down or bottom-top approach, are developed by researchers so far [12]-[14]. The effectiveness of this channel generator depends upon the variety of factors considered in estimating the distributed parameters (R, L, G, and C). The factors influencing the distributed parameters are skin and proximity effect, cable geometry, number of strands in the cable, and size of the conduit.

In [15], the authors have estimated the distributed parameters based on the various factors influencing the Indian Residential Networks. However, there are yet certain dynamic aspects to be included in these PLC channel models.

1) *Top-down Approach*: The commonly used top-down approach is the Zimmerman & Dostert model. This model takes into account the multipath nature exhibited due to the time-varying loads and impedance mismatches in the network. The channel transfer function using this approach is expressed as follows:

$$H(f) = \sum_{i=1}^N g_i e^{-(a_0+a_1 f^k) d_i} e^{-j2\pi \frac{d_i}{V_p} f} \quad (1)$$

Here, N is the paths taken by the signal; g_i is the signal gain obtained from the transmission and reflection coefficients of each path, d_i is the distance of each path taken, and V_p is the signal velocity. The parameters a_0 , a_1 and k determine the attenuation of the signal. Since these parameters are obtained from measurements, the complexity in obtaining the channel model increases with the increase in the number of branches.

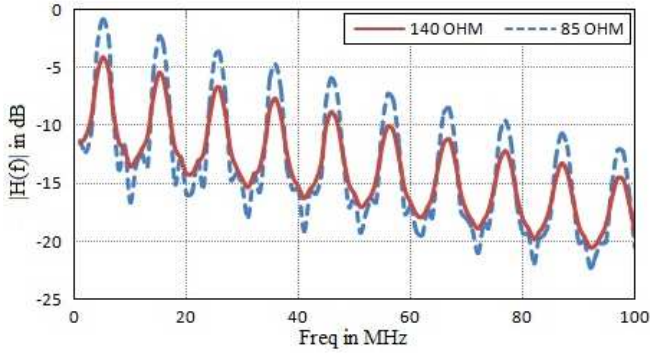

Fig. 2 CTF using top-down approach for different loads connected

Using the multipath propagation model of top-down approach, the CTF has been obtained for the network with different branch length and loads connected to it. From Fig. 2, it can be noticed that, if an electrical appliance, say 85Ω , is replaced with another appliance, say 140Ω , the signal attenuation is increased. The average attenuation in case of 85Ω load is -13.6063 dB but in case of 140Ω , the attenuation is increased to -13.6473 . This explains the impact of the load on the signal attenuation and the complexity involved in modeling the network with dynamic loads.

In addition to the load impedance, the branch to which the load is connected also affects the signal attenuation. Since the residential network configurations will have different branch lengths with different types of loads connected; the CTF will also vary accordingly.

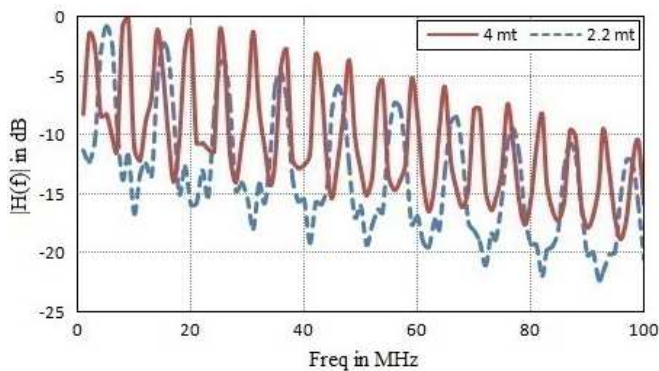

Fig. 3 CTF using top-down approach for different branch length

The complexity of this method is evaluated by considering two similar loads connected to two different branch lengths of the network. The CTF is estimated by connecting one of the loads to a branch of 2.2 mt lengths and

the other to 4 mt lengths. The average attenuation in this case as increased from -10.6343 to -13.6063 . From the Fig. 3, it can also be noticed that the notch position has decreased with increase in the branch length. With the increase in branch length, the notch positions have decreased, thereby increasing the attenuation of the signal. The notch positions in the CTF measured are due to the reflections from the branch nodes [12]. Since the electrical loads connected to the power line are dynamic, the reflections from the branch nodes may vary and hence the notch positions.

This problem is addressed in [16] by considering the unmatched loads as line terminations and extending the equation as

$$H(f) = A \sum_{i=1}^N (g_i + c_i f^{K_2}) e^{-(a_0+a_1 f^k) d_i} e^{-j2\pi \frac{d_i}{V_p} f} \quad (2)$$

Here, A is the constant coefficient for adjusting the attenuation. c_i is also a signal gain similar to g_i and K_2 is the attenuation constant.

2) *Bottom-top Approach:* In this approach, the CTF can be obtained either by transmission line model or S-parameter model. The advantage of this approach is the ease in dealing with complex electrical networks.

In the transmission matrix model, a network with a large number of branches can be divided into multiple sections, and a matrix is obtained for each section [17]. The obtained matrices can be cascaded together to form a chain matrix as

$$T = \prod_{i=1}^N T_i = \begin{bmatrix} T_{11} & T_{12} \\ T_{21} & T_{22} \end{bmatrix} \quad (3)$$

With the relation between transmission line theory and chain matrix, the CTF can be obtained as [17]

$$H(f) = \frac{Z_L}{T_{11}Z_L + T_{12} + T_{21}Z_S Z_L + T_{22}Z_S} \quad (4)$$

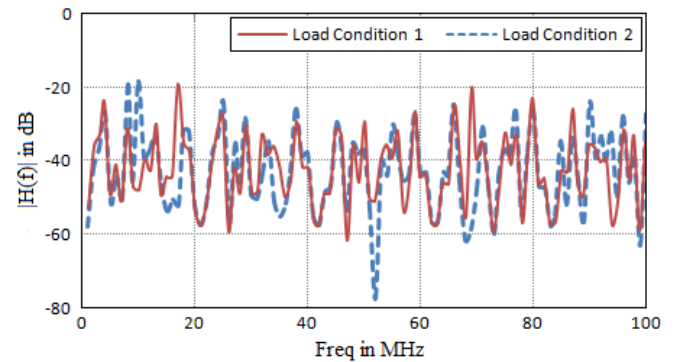

Fig. 4 CTF using a bottom-top approach for different load conditions

The CTF of the network is obtained using the transmission line model. Taking advantage of this approach, two complex networks with five branches and wiring cross-section of 1.5 sq. mm is considered. In the first load condition, five loads with an impedance of 60Ω , 80Ω , 90Ω , 110Ω and 140Ω are connected to branches of length 1.5 mt, 2.2 mt, 3 mt, 3 mt, and 4 mt respectively. In the second load condition, five loads with an impedance of 65Ω , 80Ω , 100

Ω , 110 Ω and 140 Ω are connected to branches of length 1.5 mt, 3 mt, 3.5 mt, 3 mt, and 4 mt respectively.

The CTF estimated for these two different load conditions are shown in Fig. 4. The average attenuation for the first load condition is -42.3368, and for the second load condition, it is -42.7955. The increase in attenuation for the second load condition can be attributed to the increase in the average load impedance and branch length. The variation in the peaks and valleys of the CTF can be observed in Fig. 4, and this is due to the difference in the electrical appliances used in each of the load condition.

Though the bottom-top approach can deal with complex networks, the difficulty will remain in dealing with dynamic networks.

The S-parameter model is similar to transmission model except that the former model can also be used for a network with different cross-sections in branch cables.

The S-parameter model can be interrelated with transmission matrix model as

$$\begin{bmatrix} S_{11} & S_{12} \\ S_{21} & S_{22} \end{bmatrix} = \begin{bmatrix} \frac{T_{21}}{T_{11}} & T_{22} - \frac{T_{21}T_{12}}{T_{11}} \\ \frac{1}{T_{11}} & -\frac{T_{12}}{T_{11}} \end{bmatrix} \quad (5)$$

C. Statistical Characterization

The channel generator developed by traditional approaches reflects the behavior of the power line at an instant. However, by performing statistical analysis, the dynamic nature of the power line may also be estimated.

1) *Channel Transfer Function*: An alternate way of characterizing the power line channel is to measure the channel transfer function and then perform the statistical analysis. As per the Fig. 2, the measured channel transfer function exhibits an exponentially decreasing nature, and the equation can model this approach as in the formula below.

$$H(f) = a \cdot f^b + c \quad (6)$$

Here, parameter 'a' represents the maximum attenuation of the signal, parameter 'b' represents the attenuation of the signal at the initial frequency, and parameter 'c' represents the variation in attenuation concerning frequency.

2) *Average Channel Gain*: The average channel gain can be expressed as the average attenuation and is expressed as

$$ACG_{dB} = 10 \log_{10} \left(B \frac{1}{f_2 - f_1} \int_{f_1}^{f_2} |H(f)| df \right) \quad (7)$$

Here, H(f) is the transfer function measured at a frequency f, f_1 and f_2 are the start and stop frequencies at 0.5 MHz and 100 MHz respectively.

3) *Line Impedance*: During the campaign, the line impedance of the electrical network is also measured simultaneously. The impedance is deduced from the ABCD matrix, which in turn, is derived from the S parameters obtained using VNA. However, these ABCD parameters also include the coupling circuit. The ABCD matrix can be obtained from the S parameters as [18],

$$A = \frac{(1+S_{11})(1-S_{22})+S_{12}S_{21}}{2S_{21}} \quad (8)$$

$$B = \frac{50 \cdot [(1+S_{11})(1+S_{22})-S_{12}S_{21}]}{2S_{21}} \quad (9)$$

$$C = \frac{(1-S_{11})(1-S_{22})-S_{12}S_{21}}{100 \cdot S_{21}} \quad (10)$$

$$D = \frac{(1-S_{11})(1+S_{22})+S_{12}S_{21}}{2S_{21}} \quad (11)$$

The Impedance of the power line is estimated in a two-step procedure. In the first step, the coupling circuit and power line are considered as two networks cascaded together. Here ABCD parameters of the coupling circuit are estimated using VNA and the power line is considered as an infinite line with ABCD matrix of [1 0 Y 1]. In the second step, the ABCD parameters of the coupling circuit are eliminated from (8) to (11), and the impedance of the power line is obtained as

$$Z = \frac{\left(A + \frac{B}{Z} - CZ - D - S_{11} \left(A + \frac{B}{Z} + CZ + D \right) \right)}{\left(B(S_{11}-1) + DZ(S_{11}+1) \right)} \quad (12)$$

The impedance obtained from the measurement campaign can be modeled using a polynomial equation [8]

$$Z(f) = a \cdot f^2 + b \cdot f + c \quad (13)$$

Here a, b and c are constant parameters representing the variation in impedance across the spectrum.

4) *Noise Characterization*: This stationary noise, also referred to as background noise, is caused due to the superimposition of various noise produced by equipment such as PCs, TV, and light sources. The stationary noise displays a decreasing nature concerning frequency and can be modeled using the Esmailian model [19].

$$S(f) = a \cdot f^b + c \quad (14)$$

Here a, b and c are the constant parameters derived from the measurements.

5) *Channel Capacity*: The channel capacity determines the maximum possible transmission rate over a hostile channel and is given as

$$C = \Delta f \cdot \sum_{i=1}^N \log_2 \left[1 + \frac{P(f_n) |H(f_n)|^2}{N(f_n)} \right] \text{ bits/s} \quad (14)$$

Here P(f) and N(f) is the signal power spectral density (PSD) and noise power spectral density (NSD) measured in dBm/Hz at transmitter and receiver ports respectively. H(f) is the transfer function with carrier width of Δf and N number of carriers.

III. RESULTS AND DISCUSSION

A. Channel Statistics

1) *Channel Transfer Function*: From the measurements obtained, the mean of the CTF with the corresponding fitting curve is shown in Fig. 5. It can be observed that the curve follows the pattern of the CTF largely.

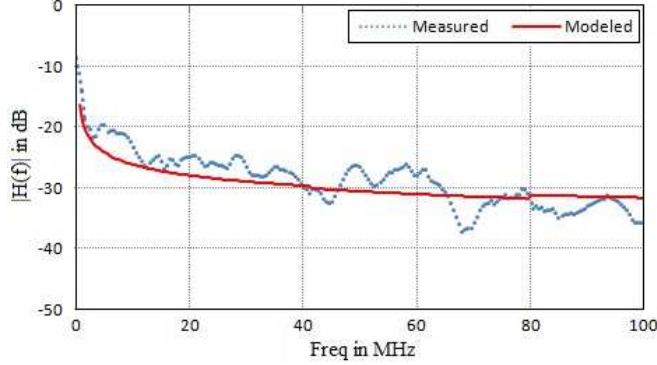

Fig. 5 Statistical model for the mean CTF

The statistics of model parameters for the measured CTF are summarized in Table 1. The normality of these parameters is verified using the Anderson-Darling (AD) test. Since the AD test gives more weight to the value in the outer tails and is more sensitive to a specific distribution, it is considered slightly superior to other tests. If the significance level of an AD test is less than 0.05, the data does not fit the normal distribution.

TABLE I
STATISTICAL PARAMETERS OF CTF

	a	b	c
Min	130.194	-0.312	-47.674
Max	3334.484	-0.093	-34.654
Mean	919.639	-0.203	-40.531
Standard Deviation	699.707	0.049	2.738
Median	949.8845	-0.21724	-40.094

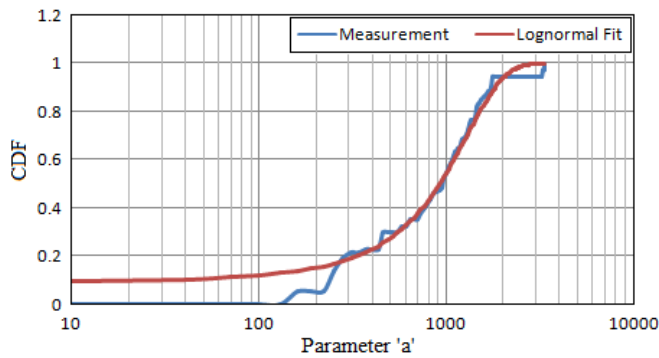

Fig. 6 CDF of parameter a

With the mean value of 919.639 and standard deviation of 699.707 the cumulative distribution function (CDF) of the parameter, 'a' is as shown in Fig. 6. From the AD test, it is verified that the data fits the log normal distribution.

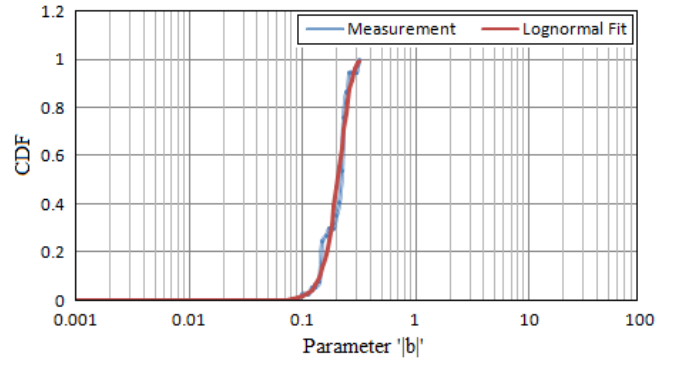

Fig. 7 CDF of absolute parameter b

With the mean value of -0.203 and standard deviation of 0.049, the CDF of the absolute value of the parameter 'b' is as shown in Fig. 7. From the AD test, it is verified that the data will approximately fit the normal distribution.

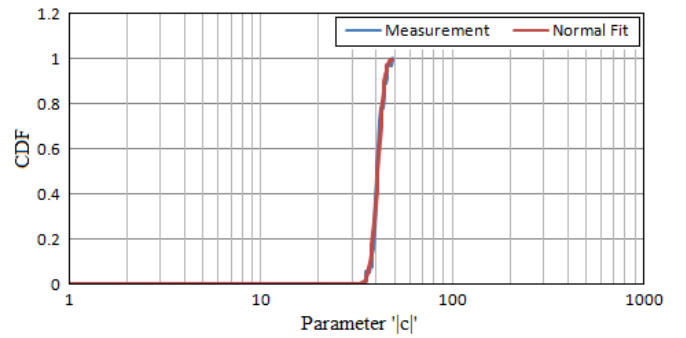

Fig. 8 CDF of absolute parameter c

With the mean value of -40.531 and standard deviation of 2.738, the CDF of absolute parameter c is as shown in Fig. 8. From the AD test, it is verified that the data will fit the normal distribution perfectly.

2) *Average Channel Gain*: For the measured CTF, the minimum and maximum values of ACA are 26.89 dB and 33.71 dB respectively. The mean and standard deviation values of ACA are 30 dB and 1.66 dB respectively. The 50th and 80th percentiles are 29.42 dB and 31.349 dB respectively. The mean value of ACA in Indian residential networks is in the same range of Brazilian in-home PLC Channels and 5 dB lesser than the PLC channels in Italy.

TABLE II
STATISTICAL PARAMETERS OF LINE IMPEDANCE

	a	b	c
Min	0.0145	-0.1531	-102.212
Max	746.133	0.4514	-72.939
Mean	244.935	-0.0318	-85.68
Standard Deviation	198.725	0.1219	6.5384
Median	241.36	-0.077	-84.652
Skew	0.646	1.933	-0.77
Kurtosis	-0.084	3.964	0.340
20th Percentile	15.526	-0.1095	-89.919
50th Percentile	241.36	-0.077	-84.652
80th Percentile	493.95	0.1055	-79.088

3) *Line Impedance*: From the measurements using (12), a diverse pattern in impedance spread across the frequency spectrum is observed. This impedance can be statistically

characterized using the modeling parameters expressed in (13) and are shown in Table 2.

4) *Noise Characterization*: The noise spectral density of the stationary noise measured in the apartment is as shown in Fig. 9. The radio interference in the form of ingress noise can also be noticed in the figure. The noise spectrum density is less than -90 dBm at a frequency less than 1 MHz and is almost constant after 70 MHz.

The statistical parameters of the modeled stationary noise are as shown in Table 3. AD test verifies the normality of these a, b and c parameters. The parameter a follows the lognormal distribution, whereas b and c follow the normal distribution.

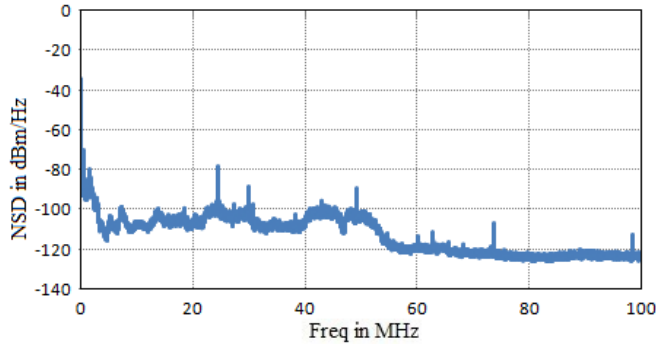

Fig. 9 Noise spectrum density

TABLE III
STATISTICAL PARAMETERS OF STATIONARY NOISE

	a	b	c
Min	306946.023	-0.72	126.18
Max	2197168.97	-0.57	128.56
Mean	957865.89	-0.66	126.92
Standard Deviation	487652.99	0.03	0.5056
Median	774955.38	-0.65	126.89
Skew	1.16	-0.21	1.025
Kurtosis	0.56	-0.30	2.126

The statistical parameters of the modeled stationary noise are as shown in Table 3. AD test verifies the normality of these a, b and c parameters. The parameter a follows the lognormal distribution whereas b and c follow the normal distribution.

1) Channel Capacity

For the measurements carried out in the frequency band of 1-100 MHz, the PSD and NSD of the signal are recorded as -50 dBm/Hz and -124 dBm/Hz respectively. With this, the minimum and maximum channel capacity is estimated at 71.5 Mbps and 97.7 Mbps respectively.

In the Fig. 10, the channel capacity is shown regarding ACG. It can be noticed that low average attenuation characterizes the channels exhibiting higher capacity.

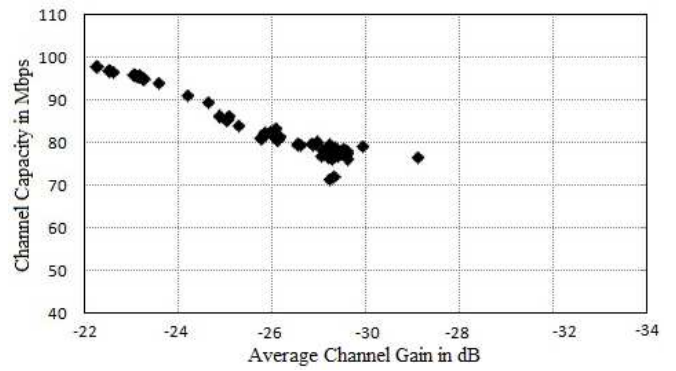

Fig. 10 Channel capacity vs. average channel gain

B. Factors influencing the Channel Transfer Function

The various dynamic aspects of the power line channel influence the channel transfer function also called as attenuation. Understanding these aspects is also necessary for refining the existent channel models.

During the campaign, the line impedance of the electrical appliances is also documented. The impedance response of a 60 W Incandescent bulb, a regular size monitor and 1200 W Vacuum cleaner is shown in Fig. 11. From the figure, it can be noticed that there is a sudden rise in the impedance of the monitor and vacuum cleaner at a particular frequency. A similar variation is experienced in other electrical appliances.

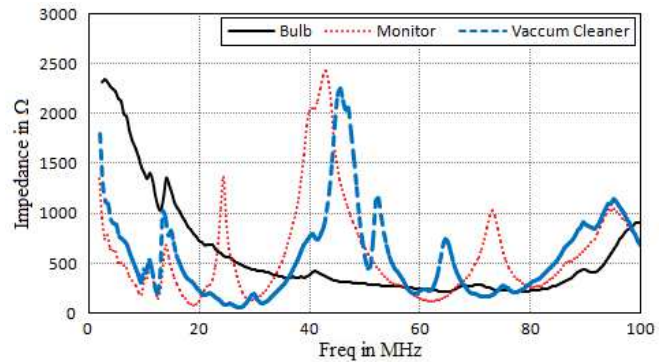

Fig. 11 The impedance measured for electrical appliances

In a residential electrical network, the electrical length of a cable does not match with the physical dimensions of the room. Moreover, the length of each branch connected to the network will vary. From the Fig. 12, it is evident that the attenuation increases with increase in the cable length.

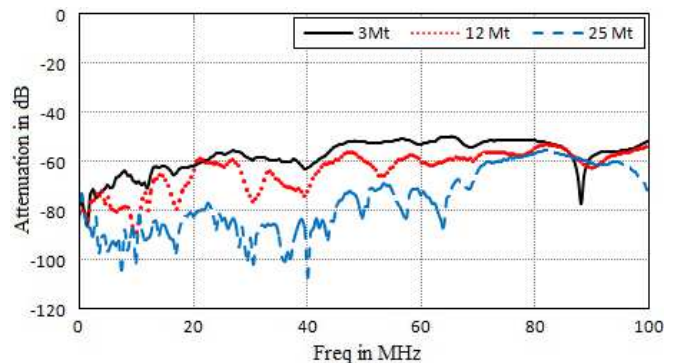

Fig. 12 Attenuation of different cable length

The electrical loads connected to the power line also contribute to the attenuation of the signal, and since these loads do not operate continuously, the attenuation due the branch cables is not constant. The attenuation of a 40 W CFL bulb, an HP printer and LCD Monitor connected to a 6-meter length branch cable is verified as shown in Fig. 13.

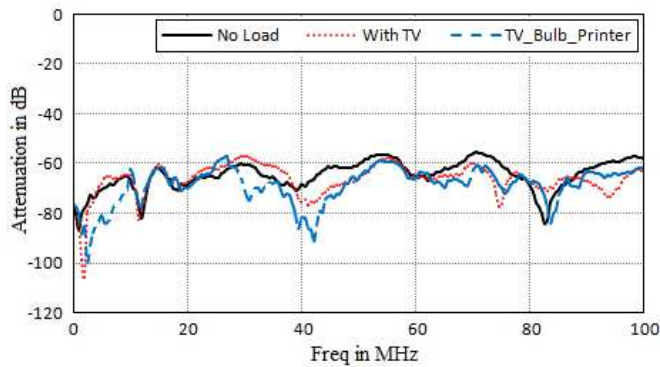

Fig. 13 Attenuation due to electrical loads

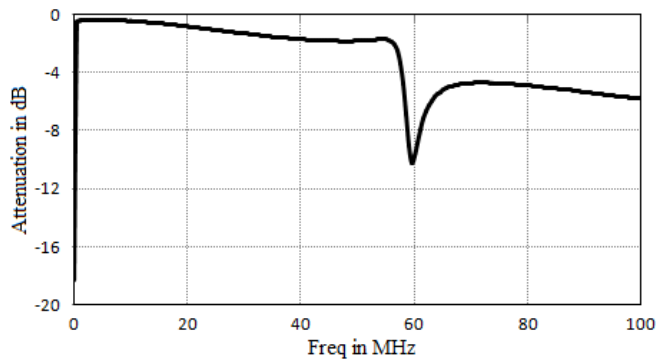

Fig. 14 Attenuation of the coupling transformer

The coupling circuit consists of a capacitor connected in series with a 1:1 transformer to isolate the measuring instrument with the high voltage power supply. For measuring the CTF, two coupling circuits, one for the tracking generator to connect with the power line and other to connect the analyzer with the power line, are used as shown in Fig. 1. The attenuation of the coupling circuit is shown in Fig. 14.

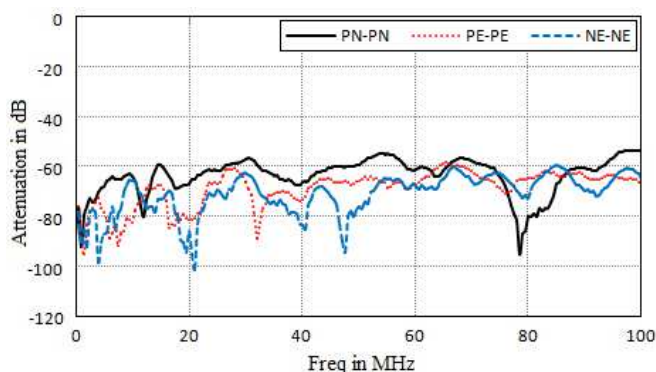

Fig. 15 Attenuation in different ports

Though the usual way of transmitting and receiving data is through Phase and Neutral wires for single-input and single-output (SISO) power line communication, the earth

wire in conjunction with either phase or neutral can also be used as an alternate option for data communication. Fig. 15 shows the signal attenuation when the data communication is either carried out between Phase-Neutral ports or between Phase-Earth ports or between Neutral-Earth ports.

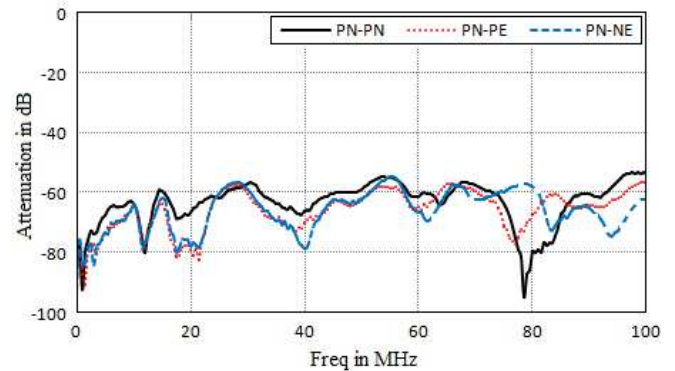

Fig. 16 Crosstalk between ports

In order to achieve higher data rates, researchers are also exploring the option of MIMO power line communication, in which all the three wires are used simultaneously for data transmission [16]. However, it is observed in Fig. 16 that, when a signal is transmitted through PN port, a corresponding strong stray signal is also found in the PE and NE receiving ports.

IV. CONCLUSIONS

In this paper, CTF is analyzed and the best distribution fit is studied using the AD normality test. The model parameters of the CTF are detected with log normality distribution, and this is similar to the campaign carried out on Italian homes [8]. The stationary noise is almost constant at -125 MHz and is -20 dBm/Hz more than the noise measure in European residential networks [1]. The normality of the data is the same as the analysis made in Tunisia [20]. The minimum and maximum channel capacity estimated on the network is at 71.5 Mbps and 97.7 Mbps respectively. This is less than the European channels, and the reason can be attributed to the decrease in the stationary noise [1]. The mean average channel gain is estimated at -30 dB and is the same as in Brazilian homes [11].

In this paper, the effect of the physical properties of the cable on the power line channel is also discussed. As the length of the cable is increased or the load impedance is increased, the signal is more attenuated. With the information provided in this paper, a power line channel model can also be developed and can be used to refine the traditional (top-down and bottom-top) approaches.

REFERENCES

- [1] OMEGA Deliverable D3.2. PLC Channel Characterization and Modeling. 2008, Seventh Framework Programme: Theme 3 ICT 213311.
- [2] Shashidhar Kasthala and GKD Prasanna Venkatesan, "Evaluation of Channel modeling techniques for Indoor Power Line Communication," *IEEE International Conference on Advanced Computing and Intelligent Engineering, Bhubaneshwar, India, December 2016.*

- [3] M.Zimmerman and K.Dostert, "A multipath model for power line channel," *IEEE Transactions on Communications*, vol. 50, Issue. 4, pp. 553-559, 2002.
- [4] Fabio Versolatto and Andrea M.Tonello, "An MTL Theory Approach for the simulation of MIMO Power Line Communication Channels," *IEEE Transactions on Power Delivery*, vol. 26, Issue. 3, pp. 1710-1717, 2011.
- [5] Stefano Galli and Thomas Banwell, "A Novel Approach to the modeling of the Indoor power line channel- part II: Transfer function and its properties," *IEEE Transactions on power delivery*, vol. 20, Issue. 3, pp. 1869-1878, 2005.
- [6] Thomas Banwell and, Stefano Galli, "A Novel Approach to the modeling of the Indoor power line channel- part I: Circuit analysis and companion model," *IEEE Transactions on power delivery*, vol. 20, Issue. 3, pp. 655-663, 2005.
- [7] L.T.Pang, P.L.So, E.Gunawan, T.T.Lie, "Characterization and Modeling of In-Building Power Lines for High-Speed Data Transmission," *IEEE Trans. on Power Delivery*, vol 18, Issue. 1, Jan 2003.
- [8] A.M. Tonello and F.Versolatto, "In-Home Power Line Communication Channel: Statistical Characterization," *IEEE Transactions on Communications*, vol. 62, Issue. 6, pp. 2096-2106, 2014.
- [9] S. Galli, "A single two-tap statistical model for power line channel," in *Proc. of International Symposium for Power line communication*, pp. 242-248, Mar 2010
- [10] M.Tilch, A.Zeddard, A.Moulin, and F.Gauthier, "Indoor Power-Line Communications Channel Characterization up to 100 MHz- Part I: One-Parameter Deterministic Model," *IEEE Trans. Power Del.*, vol 23, Issue. 3, pp. 1392- 1401. Jul 2008.
- [11] Thiago R.Oliveira, Camila B.Zellar Sergio L.Netto, and Moises V.Ribeiro, "Statistical Modeling of the Average Channel Gain and Delay Spread in In-Home PLC Channels," *IEEE International Symposium on Power Line Communication and its Applications*, 2015.
- [12] P.Mlynek, J.Misurec, M.Koutny, R.Fujdiak, and T.Jedlicka, "Analysis and Experimental Evaluation of Power Line Transmission Parameters for Power Line Communication" *Measurement Science Review*, vol. 15, Issue. 2, pp.64-71, 2015.
- [13] G.Marrocco, D.Statovci, and Martin Wolkerstorfer, FTW PLC Simulator [computer software]. Wien, Austria, 2014.
- [14] H.Meng, S.Chen, Y.L.Guan, C.L.Law, P.L.So, E.Gunawan, and T.T.Lie, "Modeling of Transfer Characteristics for the Broadband Power Line Communication Channel," *IEEE Transactions on Power Delivery*, vol. 19, Issue. 3, pp. 1057-1064, 2004.
- [15] Shashidhar Kasthala and GKD Prasanna Venkatesan, 'Experimental verification of distributed parameters on Indian residential networks for power line communication,' *International Journal of Engineering & Technology*, vol 8, Issue. 6 2016.
- [16] A.M. Tonello, F.Versolatto, B.Béjar and S.Zazo, 'A Fitting Algorithm for Random Modeling the PLC Channel,' *IEEE Trans. on Power Del.*, vol 27, Issue.3, pp.1477-1484, Jun 2012.
- [17] Shashidhar Kasthala and GKD Prasanna Venkatesan, "Estimation of MIMO Power Line Communication channel using multi-conductor transmission line theory," *2nd IEEE International Conference on Applied and Theoretical Computing and Communication Technology*, pp. 809-814, 2016.
- [18] William C.Black, "Power Line S-Parameter Characterization using Open-Source Tools," *IEEE International Symposium on Power Line Communication and its Applications*, 2015.
- [19] T. Esmailian, P. G. Gulak, and F. R. Kschischang, "A discrete multitone power line communications system," *IEEE International Conference on Acoustics, Speech and Signal Processing, Istanbul, Turkey, Jun. 2000*.
- [20] Gassara, H, F. Rouissi and A. Ghazel, "Narrowband stationary noise characterization and modeling for power line communication," 13th International Symposium on Communications and Information Technologies, 2013.