



Interference Cancellation in Cooperative CDMA Networks

A.Rajeswari¹, M.Jayasheela²

1-Coimbatore Institute of Technology Peelamedu,
Coimbatore-641014, India +91-9865907804,
rajeswari.ece.cit@gmail.com

2-SNS College of Technology Vazhiyampalayam,
Coimbatore-641035, India, +91-9965258822
Jayasheela.ece.snsct@gmail.com

Abstract— The wireless communication networks are subjected to multi access interference and multipath fading. To minimize the interference cancellation in CDMA networks, multiple user detection schemes and cooperative communication networks are used. consider the uplink of a cooperative CDMA network, where users cooperate by relaying each other's messages to the base station. When spreading waveforms are not orthogonal, multiple access interference (MAI) exists at the relays and the destination, causing cooperative diversity gains to diminish. To overcome this problem, we integrate various multiuser detection (MUD) schemes to mitigate MAI in achieving the full advantages of cooperation. Specifically, the relay-assisted decorrelating multiuser detector (RAD-MUD) is proposed to separate interfering signals at the destination with the help of precoding at the relays along with pre-whitening at the destination. In this paper we examined the BER performance of various MUD schemes are analyzed and compared with cooperative system. The advantages of RAD-MUD with co-operative communication shows better BER performance compared with non co-operative wireless communication system and other existing cooperative MUD schemes are also shown through MATLAB Simulations.

Keywords— CDMA, Maximal Length Sequences, Cooperative Communication, Multi User Detection Schemes (MUD).

I. INTRODUCTION

Transmit diversity requires more than one antenna at the transmitter. However many wireless devices are limited by size, cost, and hardware complexity. By using cooperative communication, multiple virtual antenna transmitters can be considered. Distributed diversity can be implemented by the use of relaying. A relay channel is a three terminal network consisting of a source, relay and destination. In cooperative communication, transmission through destination node is done by sharing system resources and cooperating to transmit each other's data. Many cooperative communication strategies have been proposed in literature[8] based on relaying techniques such as i) Amplify and forward ii) Coded cooperation iii) Quantize and forward iv) Decode and forward In this paper, the decode and forward scheme

has been implemented where the relays decode and re-encode the source messages, before re-transmitting them to the destination, The relays form a distributed antenna array for each source using only one antenna at each node. Most existing works on cooperative communication assume that there is only one source in the network (while all the other users serve as relays) or that there are multiple sources but each transmits over an orthogonal channel, which implies the availability of orthogonal spreading codes. However, in practical systems, the requirement of orthogonality is difficult to satisfy and thus MAI cannot be ignored. In our proposed system, MUD has been implemented for pair-wise cooperative systems, where each user is grouped with another user in a cooperative pair and is only allowed forwarding messages transmitted by its dedicated partner. Several multi user detection schemes [5] are available to

mitigate MAI. Some well known methods are 1) Maximum likelihood detector 2) Decorrelating detector 3) Minimum-mean square detector 4) Decision feedback detector 5) Successive interference cancellation schemes 6) Parallel interference cancellation schemes ML-Detector minimizes the error probability but has a complexity that increases exponentially with the number of users. To address this issue, a linear Decorrelating and MMSE receivers, which require only polynomial complexity, have been proposed. However, the reduced computational complexity comes at the cost of higher bit error rates. In particular the Decorrelating receiver eliminates MAI, but may lead to noise amplification when spreading codes are non-orthogonal. the MMSE receivers control the noise amplification up to a certain degree but results in higher residual MAI. Non-linear decision feedback and interference cancellation schemes offer good performance but experience large latency and error propagation. The rest of paper is organized as follows; Section 2 deals with System Model. Section 3 presents the Simulation Model of Proposed System. Simulation Results and Discussion are given in Section 4.

II. SYSTEM MODEL

Consider a cooperative network where K users denoted by S_1, S_2, \dots, S_K serve as sources and L users denoted by R_1, R_2, \dots, R_L serve as relays that forwards messages from the source to the destination. Each user is assigned a unique spreading code that is non-orthogonal but linearly independent from each other. The system performs two phases of transmission. Figure 1: Cooperative CDMA uplink with K sources and L relays

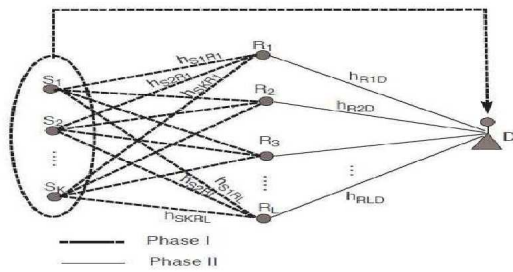

Fig 1. Cooperative CDMA uplink with K sources and L relays

2.1 Direct Transmission Phase

In Phase I, the sources send their messages directly to the destination using their respective spreading codes. The transmissions are overheard and decoded by the relays .

2.2 Cooperative Transmission Phase

In Phase II, signals are decoded and retransmitted to the destination using the same set of spreading codes. The transmissions from all users are assumed to be synchronous such that the transmitted symbols arrive at the receivers simultaneously. This unique feature of the RAD-MUD allows us to avoid both power expansion and noise amplification and thus results in better BER performance compared to existing cooperative MUD schemes.

2.3 Relay Assisted MUD

In this work, we consider a different scenario where each relay may cooperate with multiple users simultaneously. Messages received from multiple sources are decoded using multi user detector (MMSE- MUD) at the relays and are jointly processed before being retransmitted to the base station. By exploiting the relays ability to preprocess the messages we propose the relay assisted Decorrelating multi user detector (RAD-MUD) in Cooperative networks to separate (or to decorrelate) the multiple access interfering signals at the destination. These schemes perform the Decorrelating operations either entirely at the transmitter or entirely at the receiver, resulting in either power expansion at the transmitter or noise amplification at the receiver. Decorrelating MUD, RAD-MUD performs half of the Decorrelating operations at the relay and half the destination.

The signals obtained at the MFB output are subject to MAI if spreading waveforms are nonorthogonal. In this case, MUD can be employed at both the relays and the destination

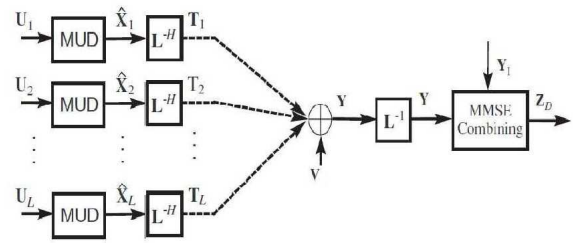

Fig 2. RAD-MUD

to mitigate MAI. For the non-cooperative CDMA system, the decorrelating MUD is used to eliminate MAI by multiplying the MFB output with the inverse of the correlation matrix. The decorrelator output at D is equal to

$$R^{-1} y = R^{-1} R X_1 + V_{//} \quad (1)$$

Although this method eliminates MAI, the noise variance may increase due to the correlation among spreading codes. To address this issue, the relay-assisted decorrelating multiuser detector (RAD-MUD) is proposed in which, with the help of precoding at the relays, allows to decorrelate the signals at the destination D without noise enhancement (I. Hammerstroem, M. Kuhn, and A. Wittneben).

Suppose that the relays (i.e., R_i , $i = 1, \dots, L$) have knowledge of the spreading codes of all sources.. The output of the cooperative operation $g(X_i)$ is then precoded by the matrix L^{-H} where L is the Choleskydecomposition of J such that $J = LL^H$ (L is a K -by- K lower triangular matrix).

$$T_1 = L^{-H} X_1 \quad (2)$$

X_1 the detected symbol matrix K -by- M matrix.

The precoding employed in RAD-MUD does not result in power expansion since the transmitted power depends only on the cooperative transmission strategy and not on the correlation of the spreading codes. With precoding at the relays, the MFB output at D is given by

$$y = RL^{-1}X_1 + V_{II} \quad (3)$$

The received signal is pre multiplied with L^{-1} . Thus; L^{-1} can be viewed as a whitening filter. v_{II} represents noise. To conclude, with precoding at the relays and pre-whitening at D, the signals transmitted by different spreading codes are decorrelated at the destination without noise amplification or power expansion.

III. SIMULATION MODEL OF PROPOSED SYSTEM

The sources transmit the random data. They are spreaded with a chip waveform. The chip waveform is generated by a PN sequence generator. After spreading the data are passing through an AWGN/ flat fading Rayleigh channel.

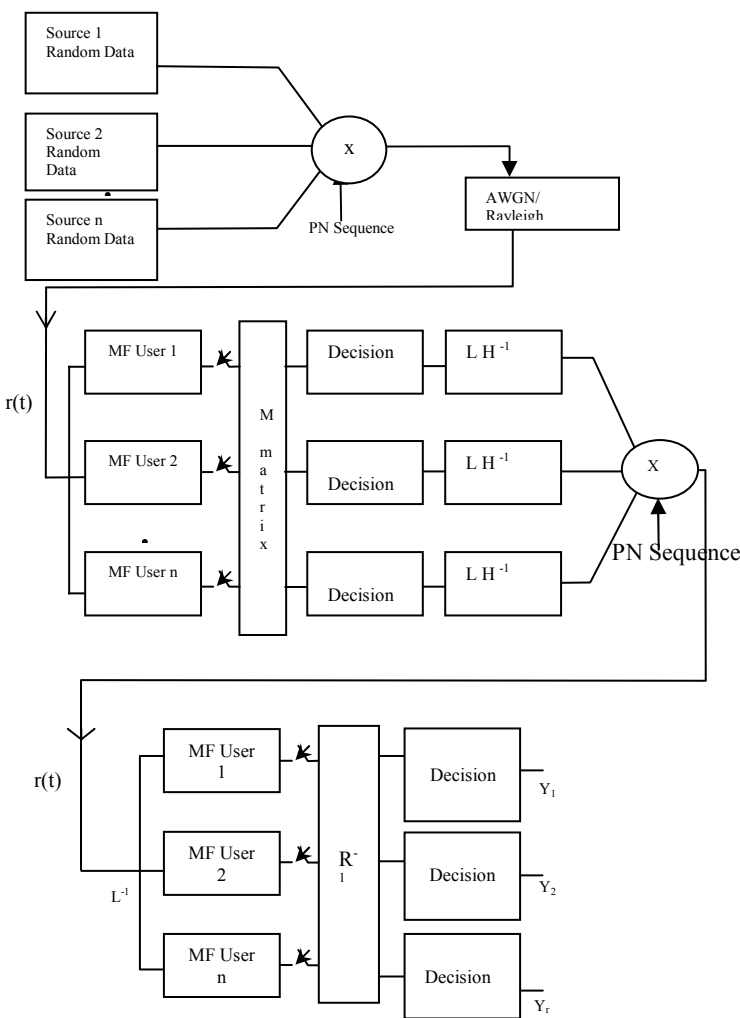

Fig 3: Simulation Model of Proposed System

The signals are over-heard by the relays where MMSE detector decodes the signals and the signals are re-transmitted to the destination. MMSE detector consists of a common matched filter followed by an M matrix and detection is done by a decision maker. Then precoding is done by Hermitian positive definite matrix. The signals are again spreaded by chip waveform from pn sequence generator. The signals are received at the destination. Pre-whitening is done at the destination. The signals are decoded by Decorrelating detector. AWGN Channel is considered because it is a stationary channel which affects the user's transmitted signal with background noise. Rayleigh fading channel is considered because it is a non stationary channel which affects the user's transmitted signal with multiuser interference. Both Channels have been considered in our simulation to account for various levels of multi user interference.

The received signal is jointly detected first by using a matched filter bank. The error between the detected sequence at the receiver and transmitted binary sequence is calculated. The number of errors divided by the total number of bits gives the BER. Throughout the simulation, it is assumed that

- the receiver has a perfect knowledge of the amplitude estimates of the different users
- spreading codes of the different users and the delays of the different transmitted signals arriving at the receiver are zero.

IV. RESULTS AND DISCUSSION

Monte Carlo simulations with a confidence interval of 95% have been run to simulate the Bit Error Rate (BER) performances of m-Sequences and m-ZCZ Sequences for different Bit Energy to Noise power spectral density ratio values (E_b/N_0) and varying number of users in AWGN channel and Rayleigh fading conditions.

TABLE I
INPUT PARAMETERS

1	Type of Spreading Sequences	m-Sequences
2	Frame length	10000
3	Type of the Channel	AWGN/Rayleigh Fading
4	Ratio E_b/N_0	2-12 dB for AWGN
5	Ratio E_b/N_0	2-12 dB for Rayleigh fading

Output Parameter

The output parameter is the Bit Error Rate for varying number of Energy to Noise Density Ratio and for varying number of users.

The simulation results for BER performance various cooperative CDMA with MUD schemes and RAD-MUD are presented using m-Sequences in figure 4 to 11.

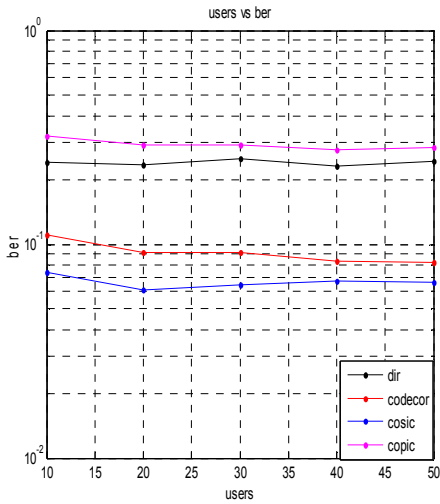

Fig 4. shows the BER performance of various MUD Schemes with and without Cooperation in AWGN channel with varying users

Figure 4. shows the BER performance of Cooperative Decorrelating MUD using m-Sequences in AWGN channel for $E_b/N_0=8\text{dB}$ with varying number of users. From this figure, it can be seen that a BER of 0.08 is obtained for 8 dB curve at 40 users and it is increased by 32 % at same number of users without Cooperation and also it is observed that as the users increases bit error rate increases

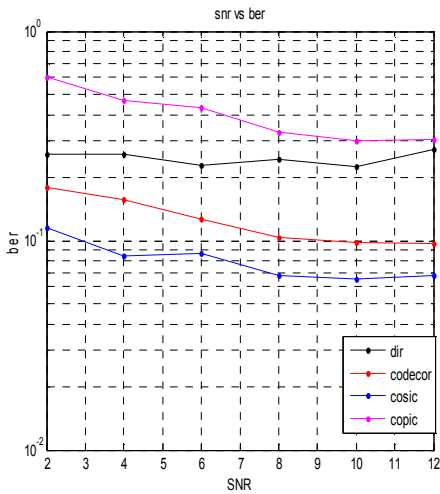

Figure 5. shows the BER performance of various MUD Schemes with and without Cooperation in AWGN channel with varying SNRs

Figure 5.shows the BER performance of Cooperative Decorrelating MUD using m-Sequences in AWGN channel for 12 users with varying SNRs. From this figure, it can be seen that a BER of 0.1 is obtained at 12 dB and it is increased by 36 % at same E_b/N_0 , without Cooperation and also it is observed that as the SNR increases bit error rate decreases

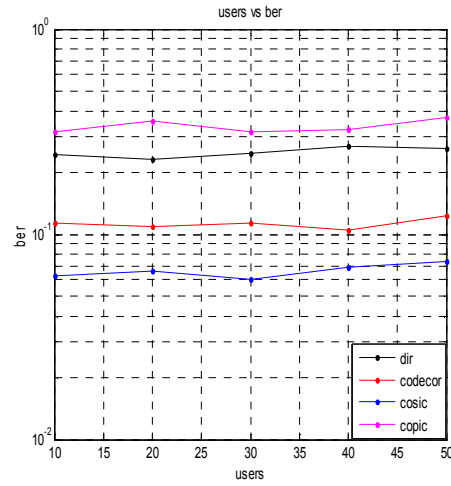

Fig 6. shows the BER performance of various MUD Schemes with and without Cooperation in RAYLEIGH channel with varying users

Figure 6. shows the BER performance of Cooperative Decorrelating MUD using m-Sequences in RAYLEIGH channel for $E_b/N_0=8\text{dB}$ with varying number of users. From this figure, it can be seen that a BER of 0.1 is obtained for 8 dB curve at 40 users and it is increased by 35.7 % at same number of users without Cooperation and also it is observed that as the users increases bit error rate increases.

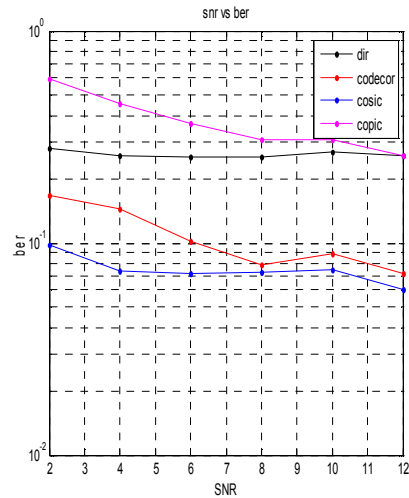

Fig 7. BER performance of various MUD Schemes with and without Cooperation in RAYLEIGH channel with varying SNRs.

Figure 7.shows the BER performance of Cooperative Decorrelating MUD using m-Sequences in RAYLEIGH channel for 50 users with varying SNRs. From this figure, it can be seen that a BER of 0.07 is obtained at 12 dB and it is increased by 25% at same E_b/N_0 , without Cooperation and also it is observed that as the SNR increases bit error rate decreases.

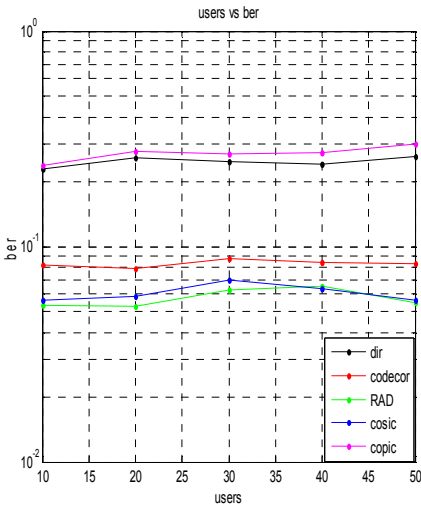

Fig 8. BER performance of RAD-MUD using various Co-operative MUD Schemes in AWGN channel with varying Users

Figure 8.shows the BER performance of Cooperative RADMUD using m-Sequences in AWGN channel for $E_b/N_0=8\text{dB}$ with varying number of users. From this figure, it can be seen that a BER of 0.05 is obtained for 8 dB curve at 15 users and it is increased by 17 % at same number of users without Cooperation and also it is observed that as the users increases bit error rate increases.

Figure 9.shows the BER performance of Cooperative RADMUD using m-Sequences in AWGN channel for 12 users with varying SNRs. From this figure, it can be seen that a BER of 0.06 is obtained at 4 dB and it is increased by 24 % at same E_b/N_0 , without Cooperation and also it is observed that as the SNR increases bit error rate decreases.

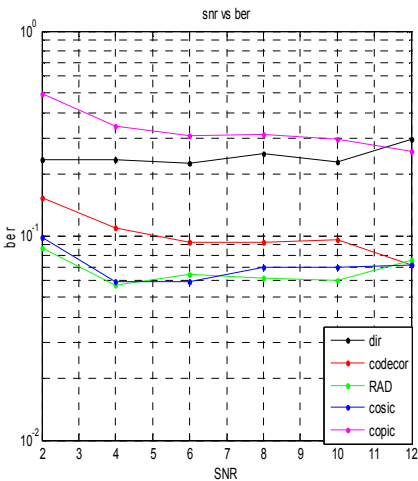

Fig 9. BER performance of RAD-MUD using various Co-operative MUD Schemes in AWGN channel with varying SNRs

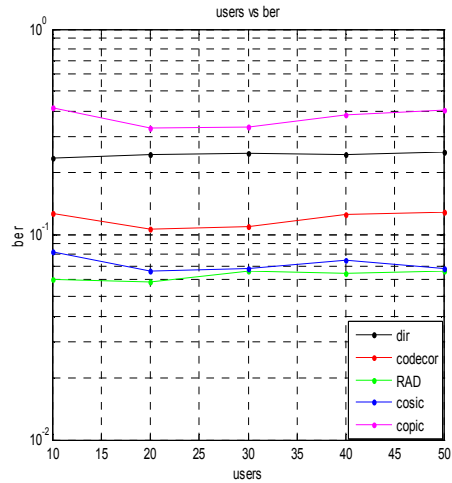

Fig 10. BER performance of RAD-MUD using various Co-operative MUD Schemes in RAYLEIGH channel with varying Users

Figure 10.shows the BER performance of Cooperative RADMUD using m-Sequences in RAYLEIGH channel for $E_b/N_0=8\text{dB}$ with varying number of users. From this figure, it can be seen that a BER of 0.05 is obtained for 8 dB curve at 30 users and it is increased by 28% at same number of users without Cooperation and also it is observed that as the users increases bit error rate increases.

Figure 11.shows the BER performance of Cooperative RADMUD using m-Sequences in RAYLEIGH channel for 12 users with varying SNRs. From this figure, it can be seen that a BER of 0.065 is obtained at 8 dB and it is increased by 24 % at same E_b/N_0 , without Cooperation and also it is observed that as the SNR increases bit error rate decreases.

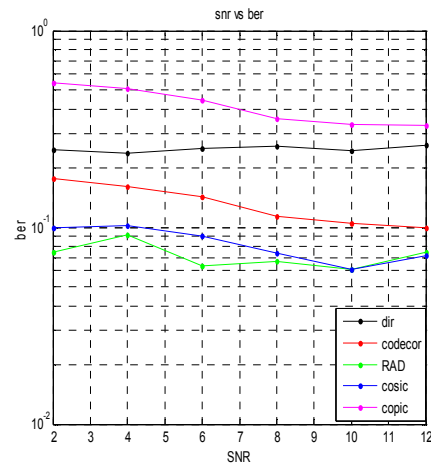

Fig11.BER performance of RAD-MUD using various Co-operative MUD Schemes in RAYLEIGH channel with varying SNRs

V. CONCLUSIONS

In this paper Monte Carlo simulations have been run to compare BER performance of Cooperative MUD Schemes under AWGN and Rayleigh fading using m-Sequences. It is observed that from the results, BER Performance of Decorrelating detector is better than that of other MUD schemes because it completely eliminates MAI. Analysis of cooperative communication reveals that MMSE at the relays and Decorrelating at the destination has better performance since MMSE controls noise amplification at the relays and Decorrelating detector eliminates MAI.

REFERENCES

- [1] Alexendra Duel-Hallen, Jack Holtzman, Zoran Zvonar, "Multiuser Detection Schemes", *IEEE Personal communications*, April 1995.
- [2] J. G. Andrews, "Interference cancellation for cellular systems: a contemporary overview," *IEEE Wireless Commun. Mag.*, 12(2):19–29, Apr. 2008
- [3] I. Hammerstroem, M. Kuhn, and A. Wittneben, "Impact of relay gain allocation on the performance of cooperative diversity networks," in *Proc. IEEE Vehicular Technology Conference (VTC)*, 2004.
- [4] Rajeswari.A, "Investigations on Multiple Access Interference Cancellation Schemes in Code Division Multiple Access Based Cellular Systems", Ph.D. *Dissertation, Anna University, Chennai, 2006.*
- [5] R. Lupas and S. Verd' u, "Linear multiuser detectors for synchronous Code- division multiple-access channels," *IEEE Trans. Inform. Theory.*, 35(1): 123–136, Jan. 1989.
- [6] Raynold. L.P, Donald L.S and Milstein L.B, 'Theory of Spread Spectrum Communication – A Tutorial', *IEEE Transactions on Communications.* 30 (5): 855-884., May 1982.
- [7] L.Venturino, X. Wang, and M. Lops, "Multiuser detection for cooperative networks and performance analysis," *IEEE Trans. Signal Processing.*, 54(9): 3315– 3329, Sept. 2006